



Flanders Research Information Space Managing Reference Data

Funding Resource Case





Sadia Vancauwenbergh

ECOOM U Hasselt

sadia.vancauwenbergh@uhasselt.be



Geert Van Grootel

Economy, Science & Innovation dept.
Flemish government

geert.vangrootel@ewi.vlaanderen.be



FRIS: Flanders Research Information Space

research institutions

industry

editors

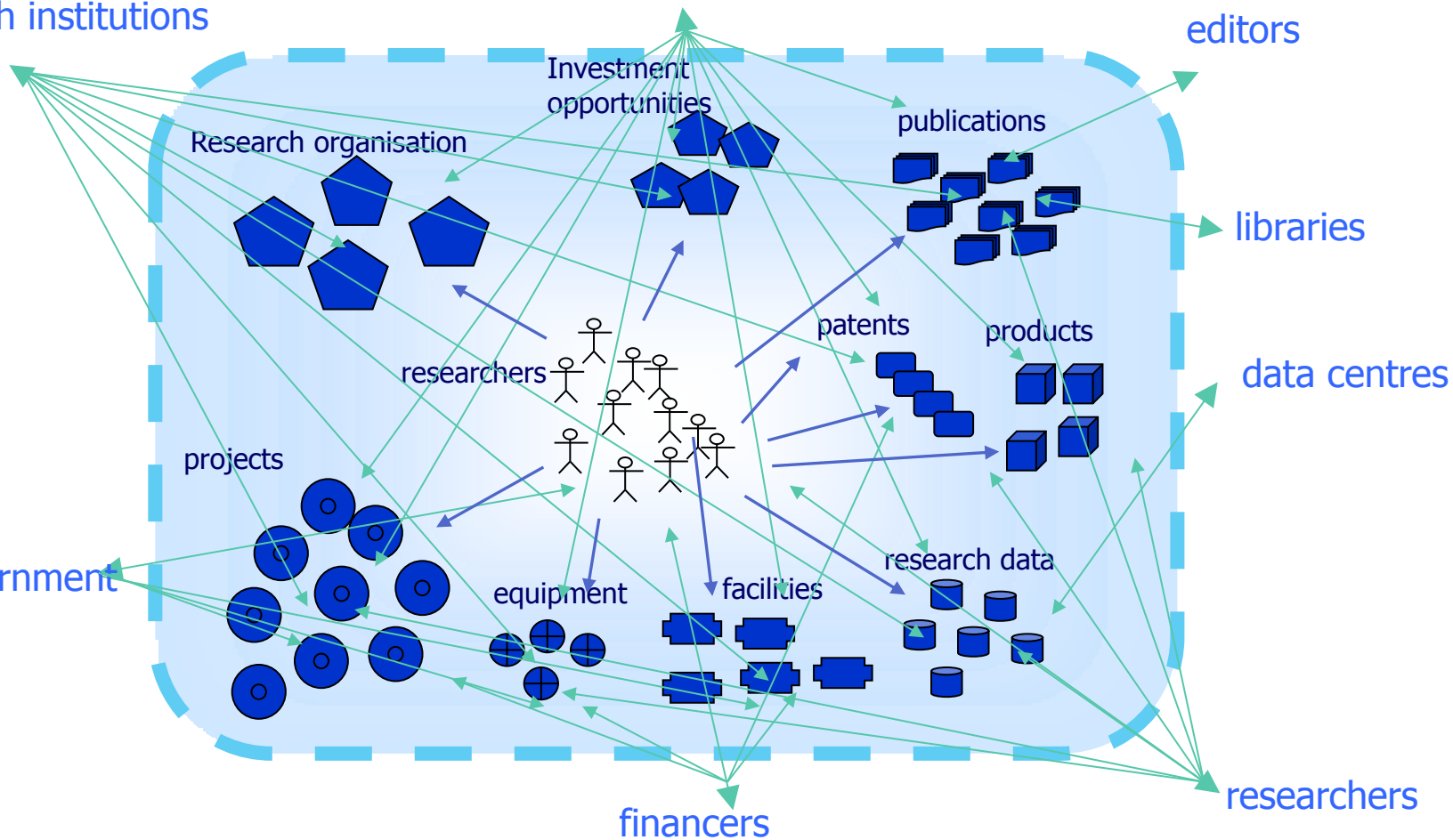

FRIS Needs & drivers

Better Research Information:
correct, actual , complete

Open FRIS data for services and
application development

Flemish government Open
Data policy

Increase strategic
intelligence

Policy monitoring:
efficient & effective

More information services

Reduce system costs

Maximum reuse of
components

Maximum reuse of data

Connect data silo's



The Data providers landscape

Universities



University Colleges



Strategic Research Centers



Research Institutes



Funders



Others



Case: Funding Source master data & Classifications

■ Approach

◆ FRIS meta model

- Coherent modelling methodology

- ◆ Business object with properties, relations and Classifications

◆ Reference data

- Reference classifications

- Reference Codes and Codes set

◆ Application integration

- Allowed value set management.



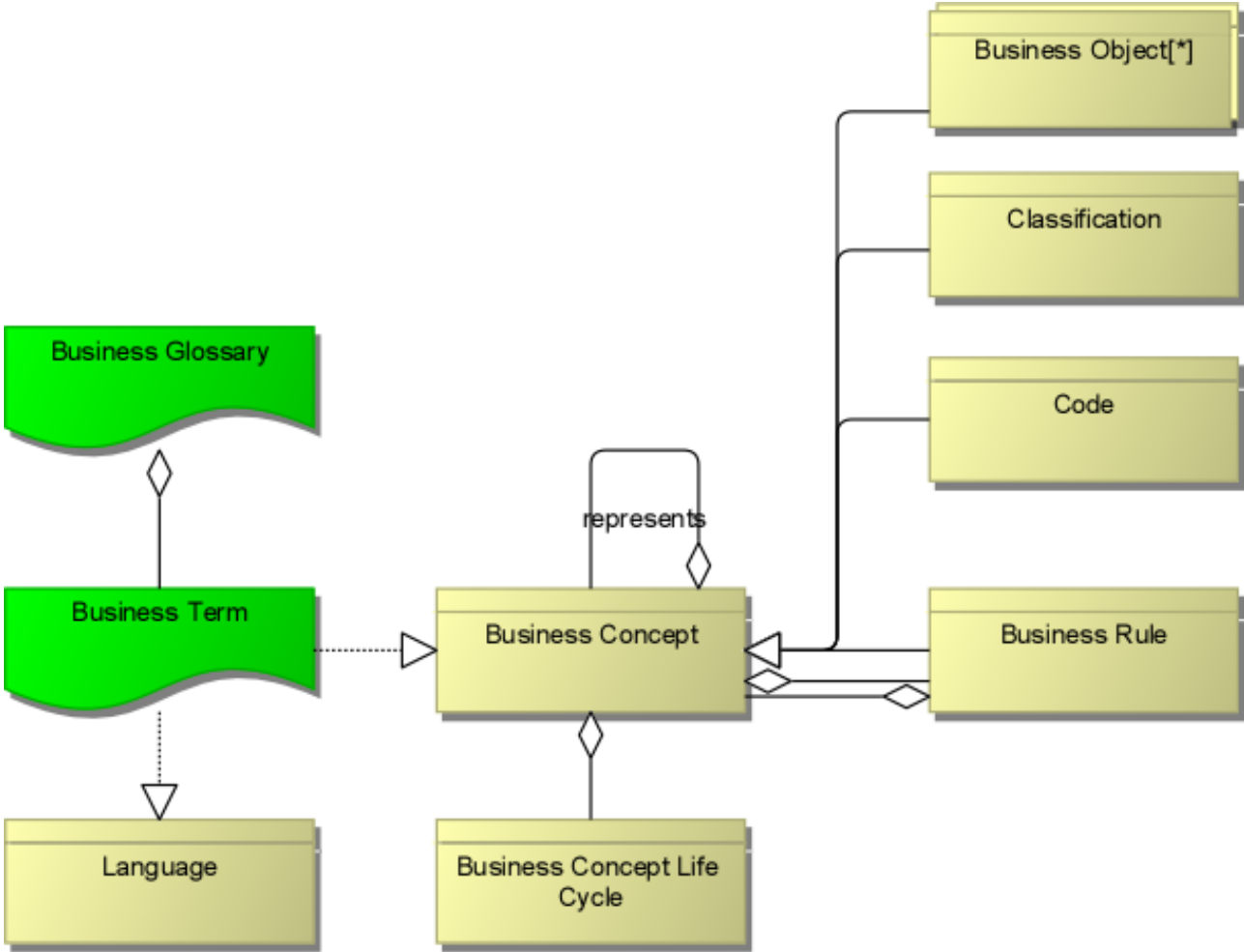

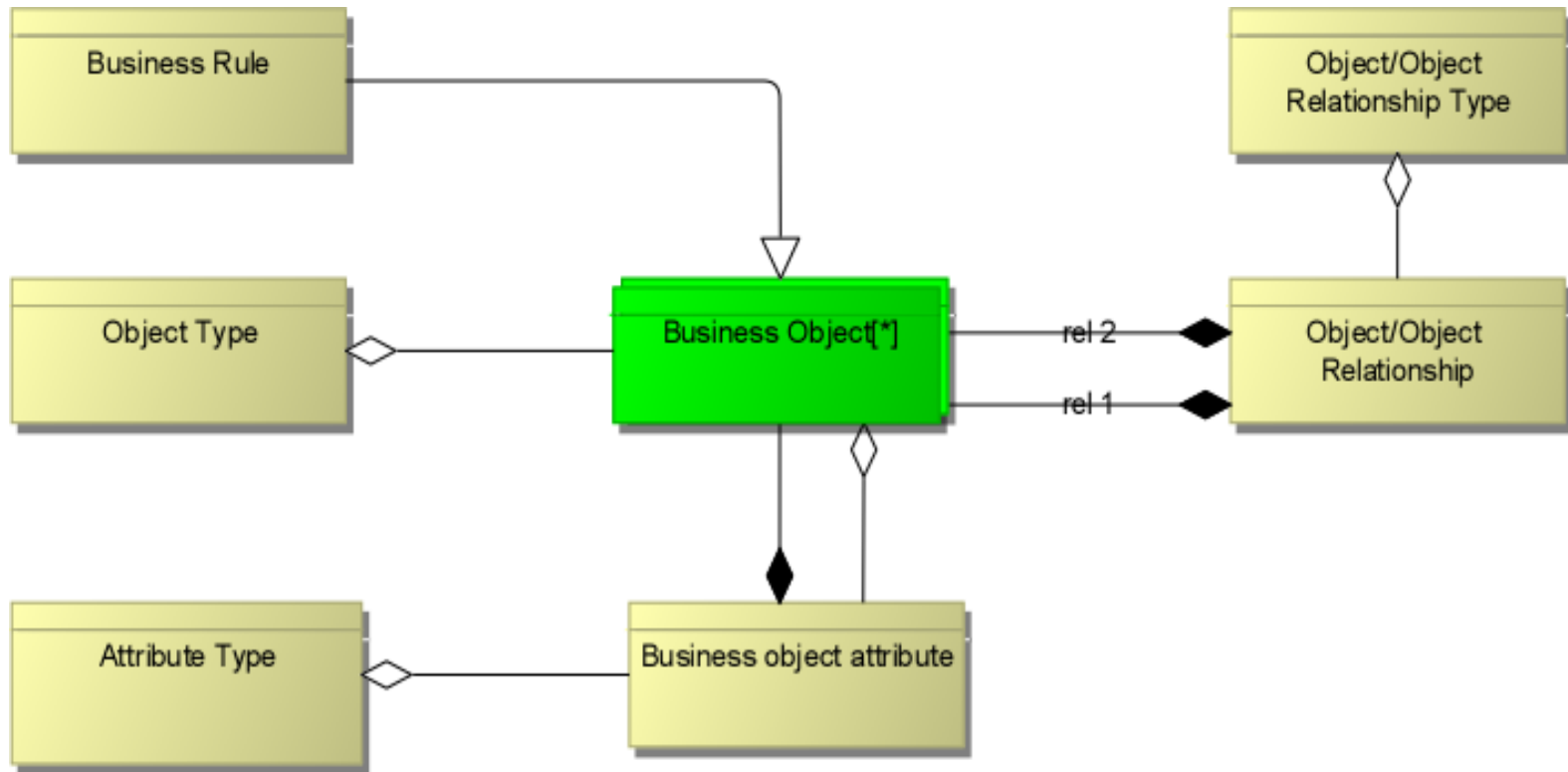

FRIS Model DGC implementation

- ✓ FRIS Model Community
- ✓ Business Object Management Comm
- Relationship Community
 - 💬 Funding Glossary
 - 💬 Identifier Glossary
 - 💬 Life Cycle Glossary
 - 💬 Location Glossary
 - 💬 Party Glossary
 - 💬 Project Glossary
 - 💬 Research Output Glossary
- 💬 FRIS Glossary
- 💬 FRIS Metamodel

Browser | Flanders Research Information Space > FRIS Model Community > Business Object Management Community > Party Glossary

Person
 Type: FRIS Business Object Status: Candidate
 Edit Move Delete Simple Approval Vote Edit Business Term Discover

Overview
 + Add

Hierarchy

Fact Types

Responsibilities
 No value has been given yet. Double click or use the edit button.

Traceability

Definition
 A physical human being

Descriptive Example
 No value has been given yet. Double click or use the edit button.

has property

Name	Definition	Descriptive Example	Domain
Birth Date	Date of Birth of a Person		Party Glossary
Family Name			Party Glossary
First Name			Party Glossary
Gender			Party Glossary
Keywords	A set of Keyword .		FRIS Glossary
Middle Name			Party Glossary
Picture			Party Glossary
URI	A resource identifier		FRIS Glossary

classified as

Name	Definition	Domain
Person Title		Party Glossary
Science Domain		FRIS Science Domains

has partnership in

Name	Definition	Description	Domain
Author	A binary relationship of a Person a An author is the party, person ...	In library cataloging, the term i...	Party to Research Output Relations Glossary
Co-promoter	The binary relationship between...		Party to Project Relationship Glossary
Collaborator	Remark: a better name for the rela		Party to Project Relationship Glossary



FRIS Metamodel: an example

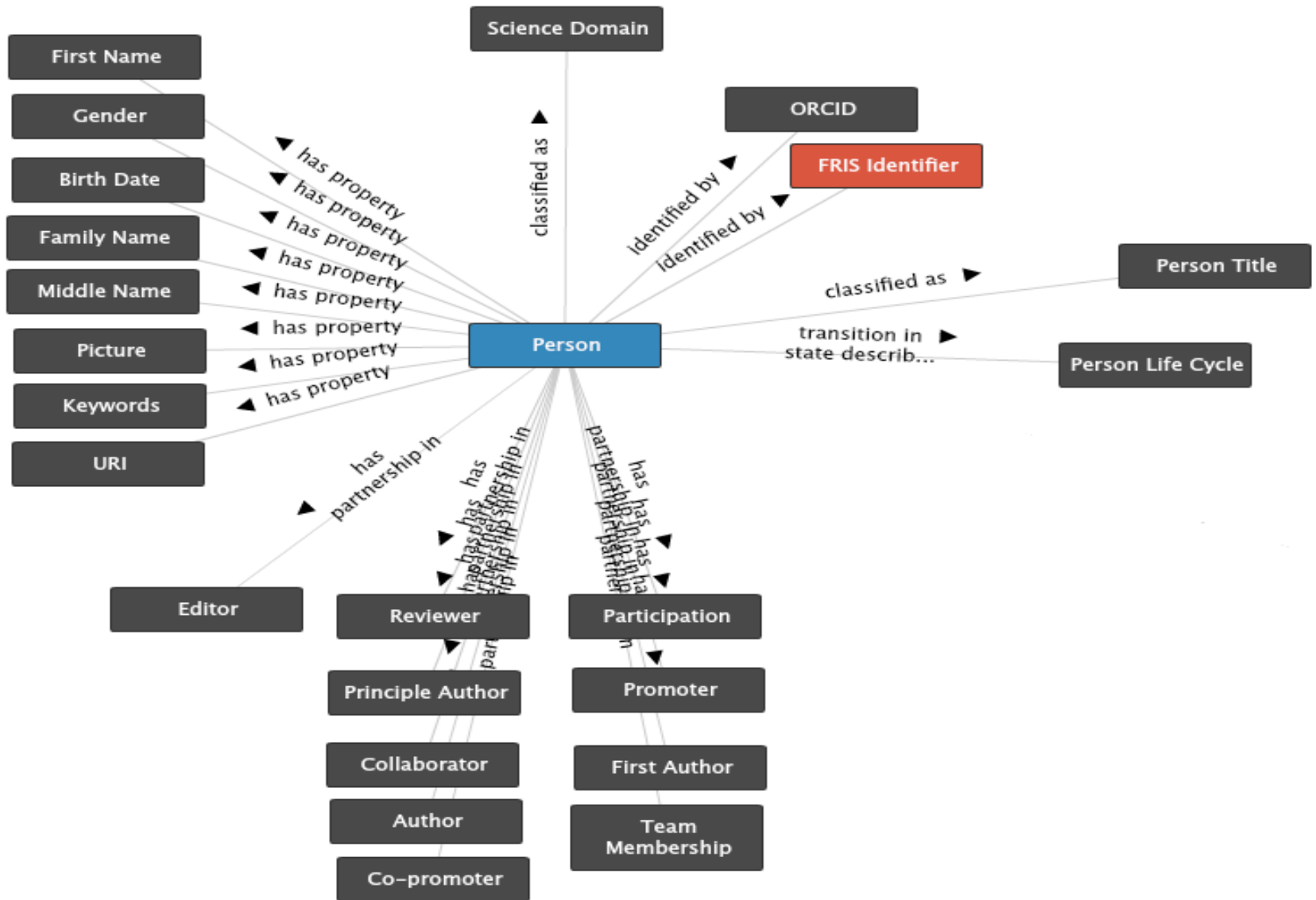

Reference Data: Funding Source

- Project Funding is obtained from a wide variety Funding Sources
- Funding Sources
 - Identified by means of a Funding Code
 - Several code generation
 - Always linked to a Funding Party
 - Organisations
 - Persons
 - Classified indifferent ways
 - Mostly by Code Schemes
 - Accounting Codes
 - Money Stream Codes
 - Functional Classifications



Proposed list May 2013							
FUNDINGID	New FundingID	OLD FUNDINGID	NAME	STARTDATE	ENDDATE	Funding Stream	ACCOUNTING CODES
1. Eigen middelen							
1001	100	1000	Eigen Middelen zoals patrimonium, inschrijvingsgelden, giften,	01/01/1980	31/12/9999	G0	704
2. Werkingstoelagen vanuit overheid							
92000	101	2000	[Uitdovende code - niet meer toekennen]	01/01/1980	30/09/1996	G1	
2.1. Universiteiten							
2101	102	2110	Univ. - Vrij onderzoek (niet-projectmatig)	01/01/1980	31/12/9999	G1	700
2102	103	2111	Univ. - Doctoraatsonderzoek mandaatassistenten	01/01/1980	31/12/9999	G1	700
2103	104	2120	Univ. - Projectmatig onderzoek	01/01/1980	31/12/9999	G1	700
2104	105	2130	Univ. - Teamgebonden financiering [gelden aan onderzoeksgroep toegewezen]	01/01/1980	31/12/9999	G1	700
2105	106		Univ - Diversiteitsfonds	01/01/1980	31/12/9999	G1	
2.2. Hogescholen							
2201	107	2210	HO - Vrij onderzoek (niet-projectmatig)	01/01/1980	31/12/9999	G1	
2202	108	2211	HO - Doctoraatsonderzoek assistenten	01/01/1980	31/12/9999	G1	
2203	109	2220	HO - Projectmatig onderzoek	01/01/1980	31/12/9999	G1	
2204	110		HO - Diversiteitsfonds	01/01/1980	31/12/9999	G1	
2.3. Vlaamse onderzoeksinstellingen							
2301	111	2310	VOI - Vrij onderzoek (niet-projectmatig)	01/01/1980	31/12/9999	G1	
2302	112	2311	VOI - Doctoraatsonderzoek wet. personeel binnen de opdracht v.d. instelling	01/01/1980	31/12/9999	G1	
2303	113	2320	VOI - Projectmatig onderzoek	01/01/1980	31/12/9999	G1	
2304	114		VOI - Diversiteitsfonds	01/01/1980	31/12/9999	G1	
2.4. Vlaamse wetenschappelijke instellingen							
2401	115	2410	VWI - Vrij onderzoek (niet-projectmatig)	01/01/1980	31/12/9999	G1	
2402	116	2411	VWI - Doctoraatsonderzoek wet. personeel binnen de opdracht v.d. instelling	01/01/1980	31/12/9999	G1	
2403	117	2420	VWI - Projectmatig onderzoek	01/01/1980	31/12/9999	G1	



Funding Classification Structure

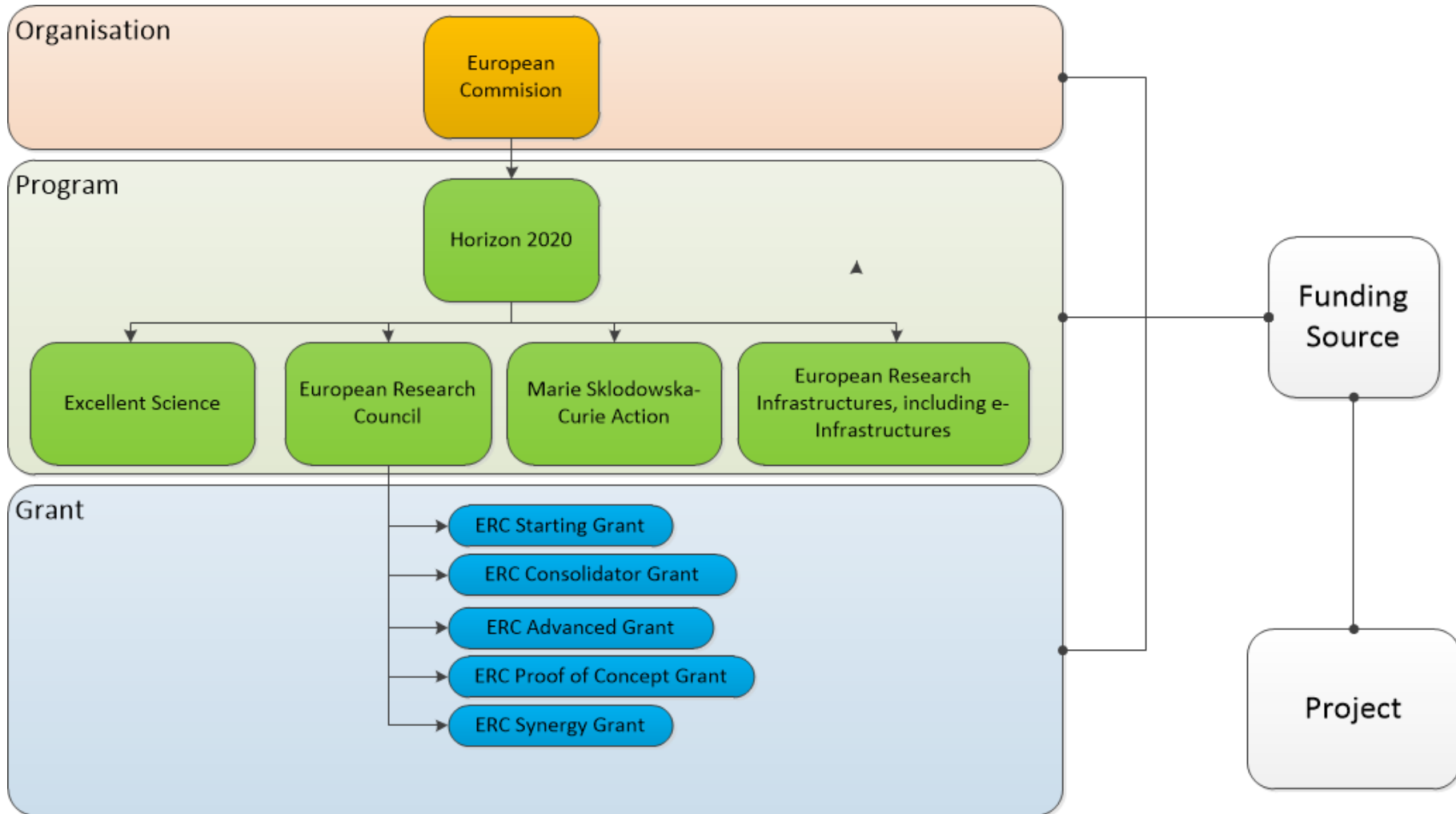

Funding Structure example

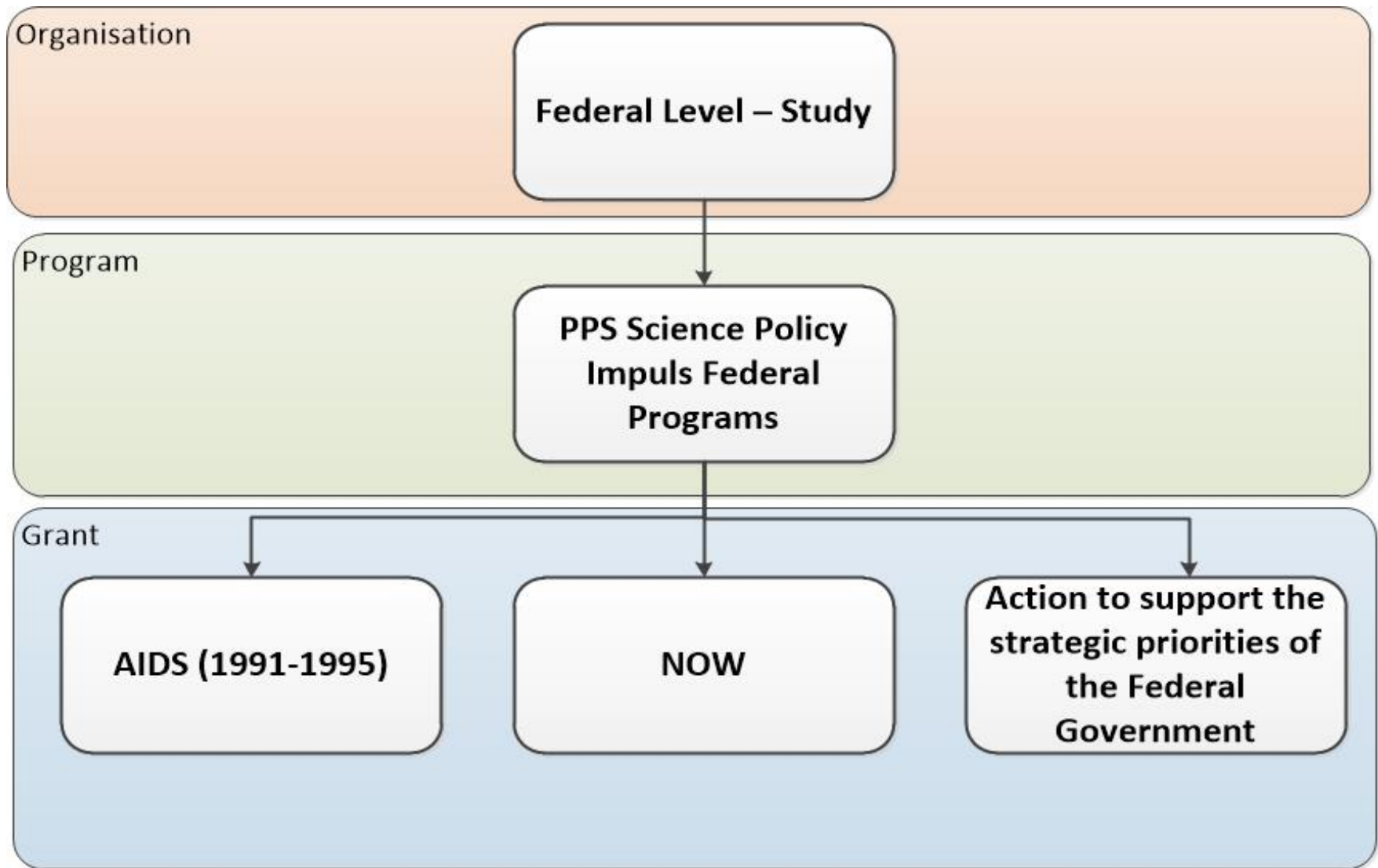

DGC setup for Funding Sources

Community, Domain, Relation and Asset Model

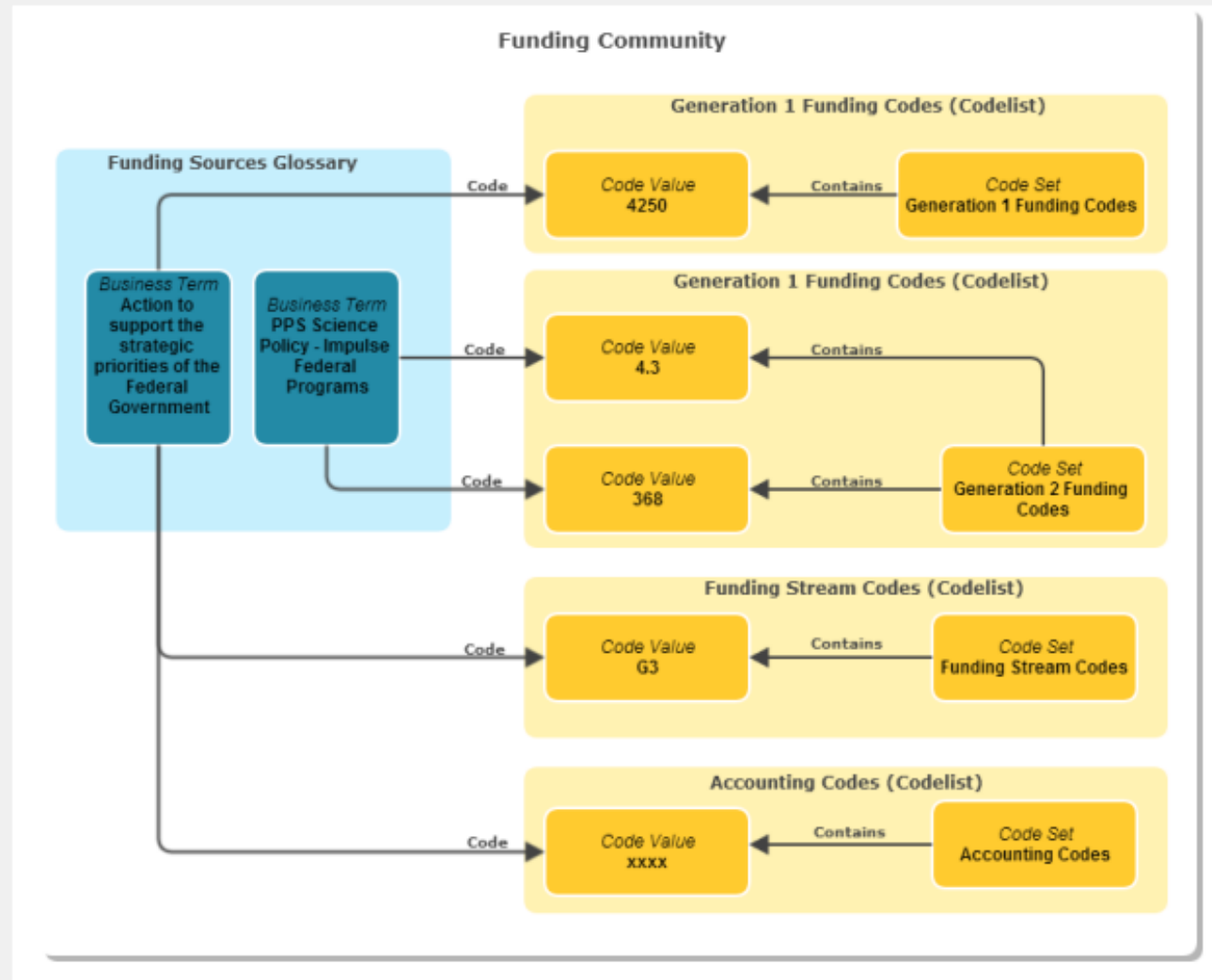

This solution model displays the **Communities, Domains, Assets, and Relations** required to be created in Collibra DGC. This diagram demonstrates the implementation in Collibra based on a small subset of **Assets**.

Collibra European User Conferences, London 28-10-2014

Traceability diagram

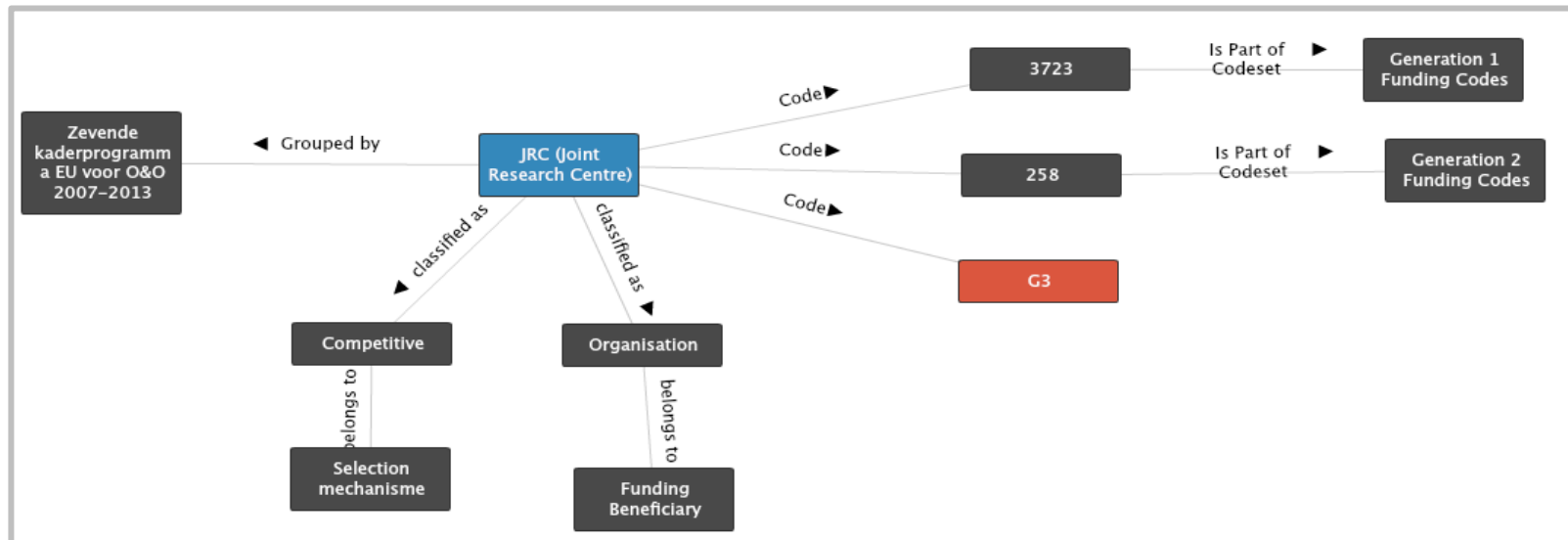

Node	Description
JRC (Joint Research Centre)	The Business Term representing the Funding Source
Zevende Kader Programma..	The Business Term representin the parent Funding Source
3723	Generation 1 Funding Code Value
258	Generation 2 Funding Code Value
G3	The Funding Stream Code Value

Traceability Diagram for Funding Stream Codes

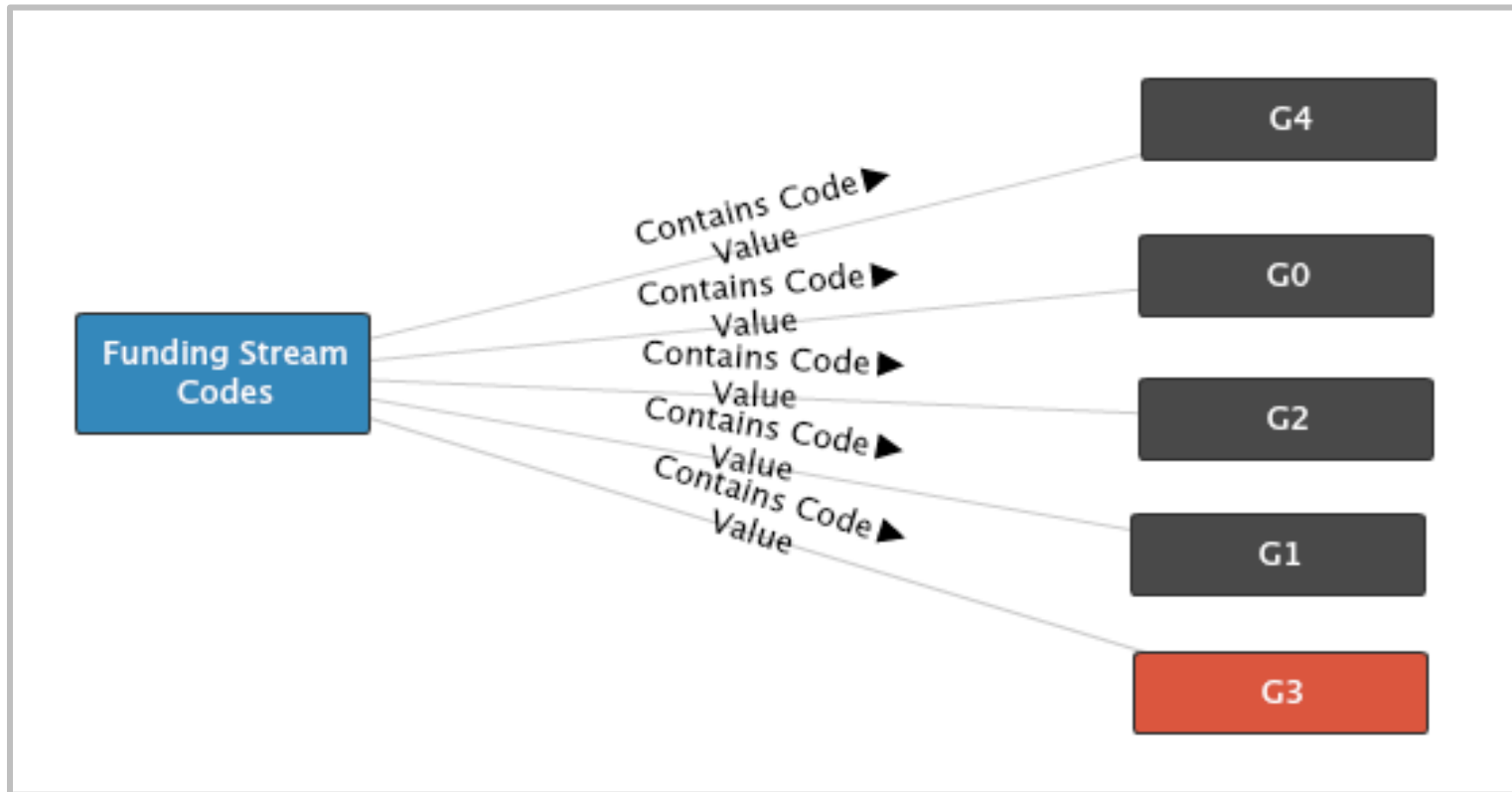

The *Funding Stream Codes Codes Set* contains all the *Funding Stream Code Values*. Codes Sets are imported as containers for Code Values

Funding Stream and Code Values in the DGC

Browser | ECOOM > ECOOM UHasselt – FINcodes

Funding Classification

Type: Glossary

Edit Delete Propose Funding Program Import Discover Export

Assets

- + Add
- Functional Classifications
- Object Type – Codes View
- More...

Responsibilities

Snapshots

Tasks

Description

There is currently no description.

Object Type – Codes View The default view to show all the assets in this domain.

Hierarchy Discover Export

<input type="checkbox"/>	Name ▲	Definition	Type	Domain	Community
<input type="checkbox"/>	Derde geldstroom	Beleidsgericht wetenschappelijk onderzoek, bij Research funding acquired by university resear	Business Object Type	Funding Classification	ECOOM UHasselt – FINcodes
<input type="checkbox"/>	C3		Code Value	Funding Stream Codes	ECOOM UHasselt – FINcodes
<input type="checkbox"/>	Eerste geldstroom	Gewone werkingstoelagen afkomstig van d... Funding provided by the government for the w	Business Object Type	Funding Classification	ECOOM UHasselt – FINcodes
<input type="checkbox"/>	G1		Code Value	Funding Stream Codes	ECOOM UHasselt – FINcodes
<input type="checkbox"/>	Nulde Geldstroom	Eigen financieringsbronnen van de universi... Financial means owned by the university itself.	Business Object Type	Funding Classification	ECOOM UHasselt – FINcodes
<input type="checkbox"/>	C0		Code Value	Funding Stream Codes	ECOOM UHasselt – FINcodes
<input type="checkbox"/>	Tweede geldstroom	Geld van de Vlaamse Overheid interuniversi... Direct funding for non-targeted scientific rese	Business Object Type	Funding Classification	ECOOM UHasselt – FINcodes
<input type="checkbox"/>	G2		Code Value	Funding Stream Codes	ECOOM UHasselt – FINcodes
<input type="checkbox"/>	Vierde geldstroom	Samenwerking met de privésector, inclusief we Research funding obtained through cooperatic	Business Object Type	Funding Classification	ECOOM UHasselt – FINcodes
<input type="checkbox"/>	C4		Code Value	Funding Stream Codes	ECOOM UHasselt – FINcodes

Funding Classifications **“Money Stream”** with associated **Code Values**.



Business Term Hierarchy

Responsibilities
Snapshots
Tasks

Custom Default The default view to show all the assets in this domain.

Hierarchy Discover Export

Name ▲	Groups	Grouped by
<input type="checkbox"/> FWO internationale mobiliteit	FWO Pegasus Marie Curie fellowships × FWO uitgaande mobiliteit ×	Fonds voor Wetenschappelijk Onderzoek (FWO) ×

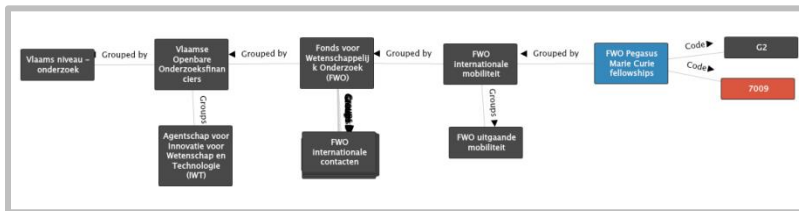

Creating Groups/Grouped by relationships between business term implements the hierarchy between the Funding Sources.



Funding Hierarchy

Browser | ECOOM > ECOOM UHasselt – FINcodes Q Search...

Funding Sources Glossary

Type: Glossary

[Edit](#)
[Delete](#)
[Propose Funding Program](#)
[Import](#)
[Discover](#)
[Export](#)

Assets

- + Add
- Grouping
- More...

Responsibilities

Snapshots

Tasks

Description

There is currently no description. [Edit](#)

Custom Default The default view to show all the assets in this domain. [Reset](#) [Save](#) [Settings](#)

Hierarchy
 Discover
 Export

 Filter

Name ▲	Definition	Groups	Steward	Status	Type
<input type="checkbox"/> Andere middelen beheerd door het FWO				Candidate	Business Term
<input type="checkbox"/> British Research Council – financiering via FWO				Candidate	Business Term
<input type="checkbox"/> Fonds voor Wetenschappelijk Onderzoek (FWO)		FWO andere individuele krediet FWO internationale samenwerki FWO – historische codes ✕ FWO internationale mobiliteit ▶ FWO onderzoeksprojecten ✕ FWO postdoctorale mandaten ▶ Herculesstichting ✕ FWO – andere acties ✕ FWO predoctorale mandaten ✕ FWO individuele kredieten ✕ FWO wetenschappelijke prijzen FWO internationale contacten ▶ FWO onbepaald ✕		Candidate	Business Term



Creating Traceability within the Grant Classification Hierarchy

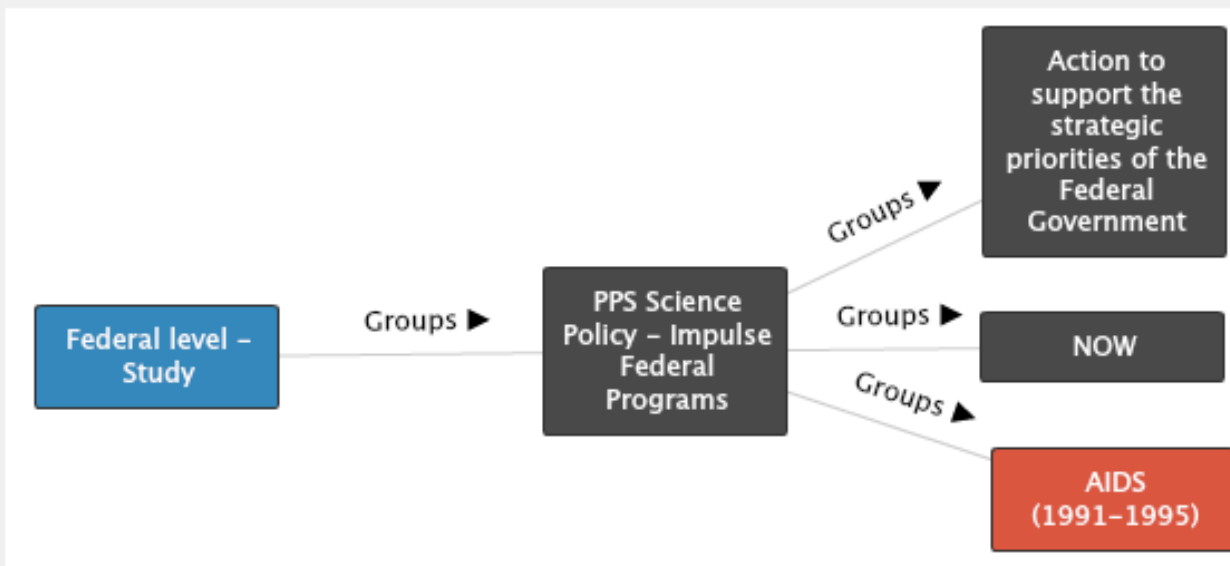

Name ▲	Groups	Grouped by
<input type="checkbox"/> Action to support the strategic priorities of the Federal Government		PPS Science Policy – Impulse Federal Programs ✕
<input type="checkbox"/> AIDS (1991–1995)		PPS Science Policy – Impulse Federal Programs ✕
<input type="checkbox"/> Federal level – Study	PPS Science Policy – Impulse Federal Programs ✕	
<input type="checkbox"/> NOW		PPS Science Policy – Impulse Federal Programs ✕
<input type="checkbox"/> PPS Science Policy – Impulse Federal Programs	AIDS (1991–1995) ✕ Action to support the strategic priorities of the Federal Government ✕	NOW ✕ Federal level – Study ✕

Creating Groups/Grouped by relations between business terms, implement the child/parent hierarchy between the grants. Notice the result in this Collibra traceability diagram:



A Screen Shot of the Glossary containing all Grants

 **Grouping**    The default view to show all the assets in this domain.

<input type="checkbox"/> Name ▲	Definition	Code
<input type="checkbox"/> > Eigen middelen		1 ×
<input type="checkbox"/> > Federaal niveau – onderzoek		4 ×
<input type="checkbox"/> FWO wetenschappelijke prijzen...		5.5.2.8 ×
<input type="checkbox"/>  Internationale samenwerking		3 ×
<input type="checkbox"/> — Achtste Kaderprogramma EU v...		3.4 ×
<input type="checkbox"/>  Andere EU programma's en init...		3.6 ×
<input type="checkbox"/> — Andere EU-programma's en...		3899 × 291 × G3 ×
<input type="checkbox"/> — EFRO/EFRD – Europees Fon...		3900 × 285 × G3 ×
<input type="checkbox"/> — EQUAL		G3 × 290 ×
<input type="checkbox"/> — ESF – Europees Sociaal Fonds		G3 × 284 ×
<input type="checkbox"/> — INTERREG / Objectives prog...		3901 × 286 × G3 ×
<input type="checkbox"/> — JASPER		287 × G3 ×
<input type="checkbox"/> — JEREMIE		288 × G3 ×
<input type="checkbox"/> — Jessica		G3 × 289 ×



Custom Data Attributes

Browser | ECOOM > ECOOM UHasselt - FINcodes > Funding Sources Glossary

JRC (Joint Research Centre)
Type: Business Term Status: Candidate

Edit Move Delete Simple Approval Vote Edit Business Term Discover

Overview
+ Add

Hierarchy
Fact Types
Responsibilities
Traceability

Definition
No value has been given yet. Double click or use the edit button.

Descriptive Example
No value has been given yet. Double click or use the edit button.

Code

Name	Description	Effective Date	Domain
258			Generation 2 Funding Codes
3723			Generation 1 Funding Codes
C3			Funding Stream Codes

Grouped by

Name	Definition	Descriptive Example	Domain
Zevende kaderprogramma EU voor O&O 2007-2013			Funding Sources Glossary

classified as

Name	Definition	Domain
Competitive		Fancode Classifications
Organisation		Fancode Classifications

Start Date
1/1/07

End Date
31/12/9999

Code Value 368 has Custom **Attribute Type** of *Effective Date* and *Deprecation Date*

368
Type: Code Value Status: Candidate

Validate Edit Move Delete Simple Approval Vote Edit Business Term Discover

Overview
+ Add

Description
No value has been given yet. Double click or use the edit button.

Effective Date Edit Delete ⓘ
01/01/2004

Deprecation Date
31/12/9999

Is Part of Codeset

Name	Description	Effective Date	Domain
Generation 2 Funding Codes			Generation 2 Funding Codes

1 relations

Business Term

Name	Definition	Descriptive Example	Domain
Actie ter ondersteuning van de Strategische prioriteiten van de Federale overheid			Funding Sources Glossary

1 relations

The *Effective Date* and *Deprecation Date* **Attributes** indicate the grant's useful time-frame. They are identical to Start and End dates of the Grants. These **Attribute Types** did not exist out-of-the-box, they had to be created in the settings

Filtered view on Custom Attributes

Code Values

More...

Code Sets

Reference Data Domains

Tasks

Metrics

Recent Changes

Snapshots

Filter Editor

A Is Part of Codeset [Code Set] equals Generation 1 Funding Codes

B Deprecation Date ends with 1996

Description contains

Filter Rule. Rearrange, reorder and combine where necessary to create a logical rule.

A AND B Filter Done

All A B C D E F G H I J K L M N O P Q R S T U V W X Y Z Other

All Code Values All list of all the code values in the system.

Reset Save

Export 7 of 5952 records Filter

Name	Is Part of Codeset	Business Term	Domain	Type
4227	Generation 1 Funding Codes	Telsat III (1993–1996)	Generation 1 Funding Codes	Code Value
4214	Generation 1 Funding Codes	Publieke economie (1992–1996)	Generation 1 Funding Codes	Code Value
4211	Generation 1 Funding Codes	Global Change (1990–1996)	Generation 1 Funding Codes	Code Value
4204	Generation 1 Funding Codes	Antarctica I (1985–1989) / II (1988–1992) / III (1992–1996)	Generation 1 Funding Codes	Code Value
4203	Generation 1 Funding Codes	Zeewetenschappen (1992–1996)	Generation 1 Funding Codes	Code Value
4103	Generation 1 Funding Codes	Interuniversitaire attractiepolen 3 (IUAP-III) (P3) (1992–1996)	Generation 1 Funding Codes	Code Value
2000	Generation 1 Funding Codes	[Uitdovende code 2000 – niet meer toekennen]	Generation 1 Funding Codes	Code Value

7 assets