



This project has received funding from the European Union's Horizon 2020 research and innovation programme under Grant Agreement No 814761

D8.1

Toolkit for vehicle operator safety

**Safe tolerance zone calculation and interventions
for driver-vehicle-environment interactions
under challenging conditions**

i  **DREAMS**

Project identification

Grant Agreement No	814761
Acronym	i-DREAMS
Project Title	Safety tolerance zone calculation and interventions for driver-vehicle-environment interactions under challenging conditions
Start Date	01/05/2019
End-Date	30/04/2023
Project URL	www.idreamsproject.eu

Document summary

Deliverable No	8.1
Deliverable Title	Toolkit for vehicle operator safety
Work Package	8
Contractual due date	28/04/2023
Actual submission date	20/04/2023
Nature	Report
Dissemination level	Public
Lead Beneficiary	CardioID
Responsible Author	André Lourenço (CardioID)
Contributions from	André Lourenço, Carlos Carreiras (CardioID) Tom Brijs, Geert Wets, Yves Vanrompay (UHasselt) Bart De Vos (DSS) Rachel Talbot, Sally Maynard (Lough) Eleonora Papadimitriou, Amir Pooyan Afghari (TUD) Klaus Machata, Susanne Kaiser, Gerald Furian (KFV)

Revision history (including peer review & quality control)

Version	Issue date	% Complete	Changes	Contributor(s)
v1.0	23/01/2023	10	Initial deliverable structure & some tentative content.	André Lourenço (CardioID)
V1.1	21/03/2023	95	Partners input incorporated & revised.	André Lourenço, Carlos Carreiras (CardioID) Tom Brijs, Geert Wets, Yves Vanrompay (UHasselt) Bart De Vos (DSS) Rachel Talbot (Lough) Eleonora Papadimitriou, Amir Pooyan Afghari (TUD) Klaus Machata, Susanne Kaiser, Gerald Furian (KFV)
V1.2	23/03/2023	98	Draft for review.	Carlos Carreiras (CardioID)
V1.3	20/04/2023	100	Incorporated feedback from internal and external reviews. Finalized References and Annexes.	André Lourenço, Carlos Carreiras (CardioID)

Disclaimer

The content of the publication herein is the sole responsibility of the publishers and it does not necessarily represent the views expressed by the European Commission or its services.

While the information contained in the document is believed to be accurate, the authors(s) or any other participant in the *i-DREAMS* consortium make no warranty of any kind with regard to this material including, but not limited to the implied warranties of merchantability and fitness for a particular purpose.

Neither the *i-DREAMS* Consortium nor any of its members, their officers, employees or agents shall be responsible or liable in negligence or otherwise howsoever in respect of any inaccuracy or omission herein.

Without derogating from the generality of the foregoing neither the *i-DREAMS* Consortium nor any of its members, their officers, employees or agents shall be liable for any direct or indirect or consequential loss or damage caused by or arising from any information advice or inaccuracy or omission herein.

Copyright

© *i-DREAMS* Consortium, 2019-2023. This deliverable contains original unpublished work except where clearly indicated otherwise. Acknowledgement of previously published material and of the work of others has been made through appropriate citation, quotation or both. Reproduction is authorised provided the source is acknowledged.

Table of contents

Revision history (including peer review & quality control)	3
Disclaimer.....	3
Copyright.....	3
Table of contents.....	4
List of Figures.....	5
List of Tables.....	7
Glossary and abbreviations.....	7
Executive Summary	9
1 Introduction	10
1.1 Document structure.....	11
2 Set of Tools.....	12
2.1 Safety Tolerance Zone.....	13
2.2 In-Vehicle Sensors & Data Processing	14
2.3 In-Vehicle Assistance.....	18
2.3.1 Display	19
2.3.2 Real-time interventions	19
2.4 Post-trip Personalized Feedback	22
2.4.1 Cloud Components and Data Flow	23
2.4.2 <i>i</i> -DREAMS App: technical overview.....	25
2.4.3 <i>i</i> -DREAMS App: Structure and Functionalities	27
2.4.4 <i>i</i> -DREAMS Dashboard: Technical Overview	33
2.4.5 <i>i</i> -DREAMS Dashboard: Structure and Functionalities	33
3 Methodologies.....	43
3.1 Detection of coping capacity and task complexity	43
3.2 Real-World Trials	46
3.3 Data Analysis	47
3.3.1 Task Complexity, Coping Capacity, and Risk.....	48
3.3.2 Analysis of Effect of Interventions.....	49
4 Exploitation Plans.....	51
4.1 Modular Exploitation	51
4.2 Expanding the <i>i</i> -DREAMS Ecosystem	53
4.2.1 Trip processing architecture for GPS trackers.....	53
4.2.2 Overview of integrated hardware	54
4.3 Mode Transferability	56
4.3.1 Rail Transport Mode	58
4.3.2 Aviation Transport Mode.....	59

4.3.3	Maritime Transport Mode.....	62
4.3.4	Summary	63
5	Policy Recommendations.....	64
6	Conclusions.....	66
	References	67
	Annex 1: Expanding the <i>i</i> -DREAMS Ecosystem installation notes	69
	Annex 2: Results of Literature Review for Knowledge Transfer between Modes	72
	Annex 3: Expert Interview Questionnaire For Knowledge Transfer Between modes.....	78

List of Figures

Figure 1:	Conceptual framework of the <i>i</i> -DREAMS platform.....	10
Figure 2:	<i>i</i> -DREAMS trial stages.	11
Figure 3:	Methodological framework behind the <i>i</i> -Dreams platform with overview of process from raw data input streams via real-time critical Safety Tolerance Zone envelope to intervention outputs.....	12
Figure 4:	Safety promoting goals and related parameters.	14
Figure 5:	In-vehicle monitoring components.	15
Figure 6:	Final CardioGateway form-factor (external and internal views).	16
Figure 7:	Data flow diagram of CardioGateway's sensor network (extracted from Lourenço et al, 2021)	18
Figure 8:	Intervention device (front and back views).....	18
Figure 9:	Driver identification GUI screens.....	19
Figure 10:	Main page of real-time interventions GUI (extracted from Lourenço et al.,2020). 20	
Figure 11:	<i>i</i> -DREAMS cloud components and data flow (extracted from Lourenço et al.,2021).	23
Figure 12:	Safety promoting goals and performance objectives (extracted from Vanrompay, 2020).	24
Figure 13:	<i>i</i> -DREAMS app functionalities (extracted from Vanrompay et al, 2020)	28
Figure 14:	<i>i</i> -DREAMS app home screen (left) and scores screen (right), (extracted from Vanrompay et al, 2020).	29
Figure 15:	<i>i</i> -DREAMS app: trips (extracted from Vanrompay et al, 2020).	29
Figure 16:	<i>i</i> -DREAMS app: coping tips (left) and pros & cons (right) (extracted from Vanrompay et al, 2020).	30
Figure 17:	<i>i</i> -DREAMS app: leaderboard (extracted from Vanrompay et al, 2020).	31
Figure 18:	<i>i</i> -DREAMS app: goals and badges (extracted from Vanrompay et al, 2020).....	31
Figure 19:	<i>i</i> -DREAMS app: shop (left) and survey (right) (extracted from Vanrompay et al, 2020).	32

Figure 20: i-DREAMS app: Forum and messages (extracted from Vanrompay et al, 2020).	32
Figure 21: i-DREAMS web platform site map (extracted from Vanrompay et al 2020).	34
Figure 22: i-DREAMS web platform: list of drivers (extracted from Vanrompay et al 2020).	35
Figure 23: i-DREAMS web platform: list of groups (extracted from Vanrompay et al 2020).	35
Figure 24: i-DREAMS web platform: group details (extracted from Vanrompay et al 2020).	36
Figure 25: i-DREAMS web platform: leaderboard (extracted from Vanrompay et al 2020).	36
Figure 26: i-DREAMS web platform: results – trips (extracted from Vanrompay et al 2020).	37
Figure 27: i-DREAMS web platform: results - trip details (extracted from Vanrompay et al 2020).	37
Figure 28: i-DREAMS web platform: results – scores (extracted from Vanrompay et al 2020).	38
Figure 29: i-DREAMS web platform: gamification - coping tips (extracted from Vanrompay et al 2020).	38
Figure 30: i-DREAMS web platform: gamification - pros and cons (extracted from Vanrompay et al 2020).	39
Figure 31: i-DREAMS web platform: gamification – goals (extracted from Vanrompay et al 2020).	39
Figure 32: i-DREAMS web platform: gamification - new goals (extracted from Vanrompay et al 2020).	40
Figure 33: i-DREAMS web platform: badges (extracted from Vanrompay et al 2020).	40
Figure 34: i-DREAMS web platform: gamification – survey (extracted from Vanrompay et al 2020).	41
Figure 35: i-DREAMS web platform: gamification – shop (extracted from Vanrompay et al 2020).	41
Figure 36: i-DREAMS web platform: gamification – phases (extracted from Vanrompay et al 2020).	42
Figure 37: i-DREAMS web platform: forum (extracted from Vanrompay et al 2020).	42
Figure 38: Conceptual framework of the i-DREAMS platform.	43
Figure 39: Safety promoting goals and related parameters.	44
Figure 40: Overview of experimental design of the i-DREAMS on-road study.	47
Figure 41: Schematic overview of modelling approaches for the analysis of risk factors.	48
Figure 42: Example of SEM model for the synthesis of risk factors.	49
Figure 43: Trip processing architecture for GPS trackers.	54
Figure 44: Connection scheme of the FMC125-based solution, taken from the installation manual.	55
Figure 45: Connection scheme of the FMC640-based solution, taken from the installation manual.	56
Figure 46: Screenshot taken from the production manual of the solution based on FMC640 GPS tracker.	69

Figure 47: Screenshot taken from the installation manual of the solution based on FMC125 GPS tracker.....	70
Figure 48: Screenshot of the web-based tool for verification of the installation.	70
Figure 49: Screenshot taken from the web-based tool for monitoring installation health.....	71

List of Tables

Table 1: Phases of the Safety Tolerance Zone.....	13
Table 2: Description of in-vehicle sensors.....	15
Table 3: Overview of data collection sensors per transport mode for the on-road field trials.	16
Table 4: Summary of CardioGateway hardware characteristics.	17
Table 5: Real-time intervention GUI: Main page symbol overview (extracted from Lourenço et al.,2020).	20
Table 6: Overview of the dedicated views for time-critical warnings (extracted from Lourenço et al.,2020)..	22
Table 7: Data variables collected per mode (extract from Talbot et al. 2021 – D3.1).	44
Table 8: Connection between the three STZ phases and the thresholds for the 4 warning strategies.....	46
Table 9: Vehicles registered in selected countries in January 2022 (Source: ACEA European Automobile Manufacturers' Association, Jan 2022)	51
Table 10: Versions of the i-DREAMS in-vehicle equipment, customized for each market.	52
Table 11: Versions of the i-DREAMS web and mobile services, customized for each market.	52
Table 12: Aviation: Risk factors, monitoring technologies, and interventions.	73
Table 13: Maritime: Risk factors, monitoring technologies, and intervention strategies.....	74
Table 14: Rail: Risk factors, monitoring technologies, and intervention strategies.	75

Glossary and abbreviations

Word / Abbreviation	Description
ADAS	Advanced Driver Assistant Systems
AVL	Automatic Vehicle Locator
CardioGW	CardioGateway
ECG	Electrocardiogram
FMS	Fleet Management System

GATT	Generic Attribute
GDPR	General Data Protection Regulation
GNSS	Global Navigation Satellite System
GUI	Graphical User Interface
HMI	Human-Machine Interface
HRV	Heart Rate Variability
IBI	Interbeat Interval
IMU	Inertial Measurement Unit
KSS	Karolinska Sleepiness Scale
LED	Light Emitting Diode
LOD	Lead-on-detection
PPG	Photoplethysmography
STZ	Safety Tolerance Zone
SWA	Steering Wheel Angle
TTC	Time-To-Collision
VRU	Vulnerable Road User

Executive Summary

The *i*-DREAMS project aims at setting up a framework for the definition, development, testing and validation of a context-aware safety envelope for driving called the 'Safety Tolerance Zone'. The main purpose of this deliverable is carry out the synthesis of the research results and the consolidation of the proposed tools, to provide a toolkit for the identification and continuous monitoring of vehicle operators' safety tolerance zone while travelling, including: i) a methodology for the detection of operators' (car, bus, truck, train) available coping capacity and the task complexity imposed on them in any given situation; ii) a set of tools for vehicle operator assistance while driving, as well as for post-trip personalized feedback, and a gamified learning and training environment; iii) exploitation plans for the proposed tools; iv) policy recommendations for the related authorities.

1 Introduction

The overall objective of the *i*-DREAMS project is to setup a framework for the definition, development, testing and validation of a context-aware safety envelope for driving ('Safety Tolerance Zone'), within a smart Driver, Vehicle & Environment Assessment and Monitoring System (*i*-DREAMS). Taking into account driver background factors and real-time risk indicators associated with the driving performance, as well as the driver state and driving task complexity indicators, a continuous real-time assessment monitors and determines if a driver is within acceptable boundaries of safe operation. Moreover, safety-oriented interventions were developed to inform or warn the driver in real-time in an effective way, as well as at an aggregated level after driving through an app- and web-based gamified coaching platform. Note, however, that the *i*-DREAMS system was not designed to directly intervene in the driving action (e.g., by braking, accelerating, or steering). Instead, it nudges and guides the driver in adopting a safe driving behaviour.

Figure 1 summarizes the conceptual framework, which was tested in a simulator study and in three stages of on-road trials in Belgium, Germany, Greece, Portugal, and United Kingdom, with a total of 600 participants representing car, bus, truck, and rail drivers.

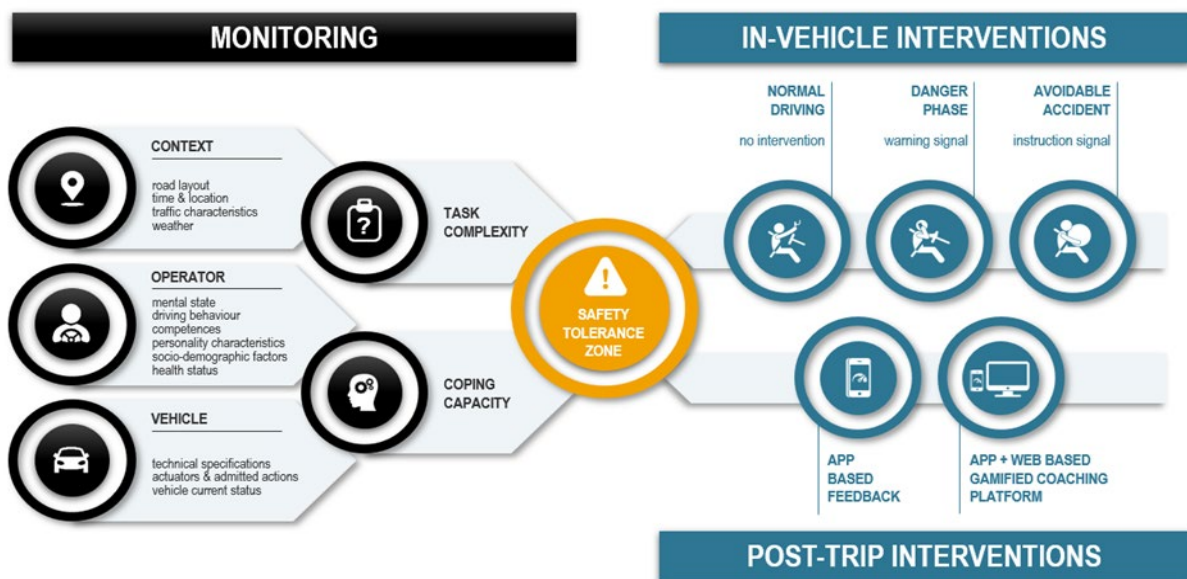

Figure 1: Conceptual framework of the *i*-DREAMS platform.

The trials took place in 4 stages, as seen in Figure 2, where the number of planned vehicles per mode and country is summarized. The stages had different durations and were aligned with the need for capturing data for each of the perspectives of the *i*-DREAMS conceptual framework.

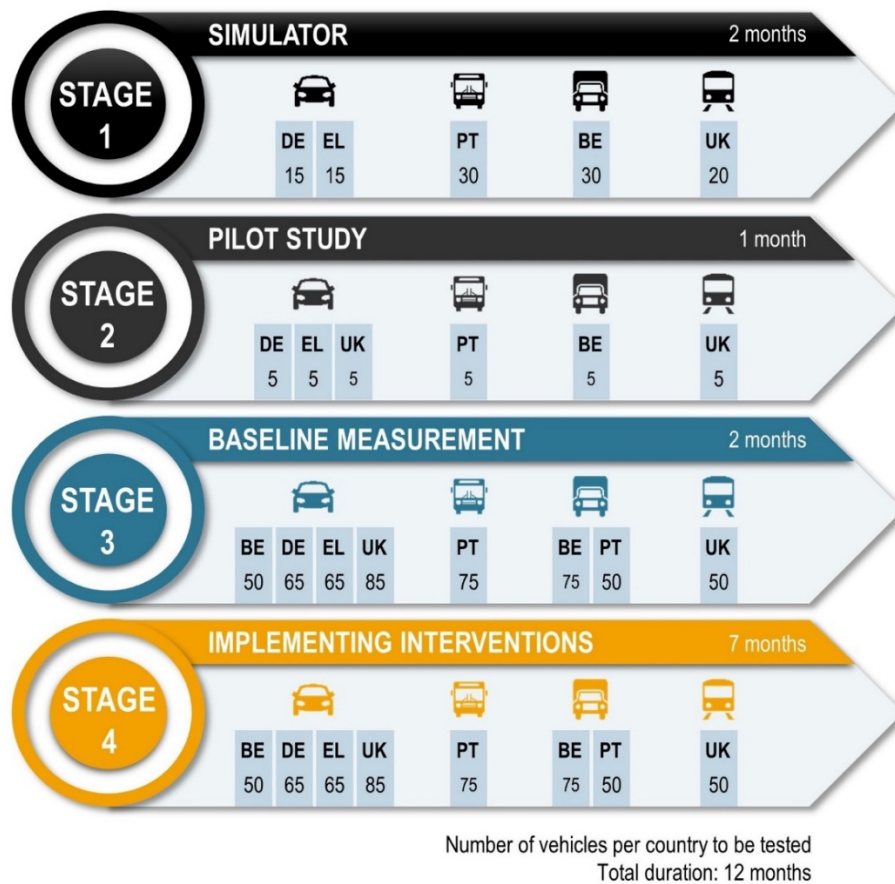

Figure 2: *i-DREAMS* trial stages.

The key outputs of the project are: i) Methodology & Tools for monitoring operator capacity & task complexity to determine safety tolerance zone while driving; ii) Intervention & Support Tools, including in-vehicle assistance, as well as feedback and notification tools, and a gamified platform; iii) a user-licensed Human Factors Database with anonymized data from the simulator and on-road experiments; iv) Exploitation Plans for commercial use of the platform; v) Policy Recommendations to implement the *i-DREAMS* platform.

1.1 Document structure

This deliverable, part of Work Package 8, will carry out the synthesis of the research results and the consolidation of the proposed tools, to provide a toolkit for the identification and continuous monitoring of vehicle operators' safety tolerance zone while driving. Section 2 describes the theoretical and conceptual backbone of the *i-DREAMS* platform, along with a description of the full set of tools employed in its implementation. Section 3 focuses on the developed methodologies to assess and measure the relationship between risk, task complexity, and coping capacity. Section 4 summarizes the proposed exploitation plans, including the modular packaging of specific tools for each target market, and the transferability of the *i-DREAMS* concepts to other transport modes. Finally, Section 5 presents an overview of the main policy recommendations targeted at public authorities and the road safety community.

2 Set of Tools

The *i*-DREAMS methodological framework (see Figure 3) was conceived in such a way that it enables the flexible integration of different technologies (sensors, questionnaires, APIs) for data collection and processing, guaranteed by using tools that enable a wide range of inputs from different sub-components. It enables the implementation of different instances of the *i*-DREAMS platform for different transport modes (indeed the *i*-DREAMS architecture supports this flexibility such that the system does not need to be redesigned from scratch for each mode of transport). Furthermore, the *i*-DREAMS framework enables independent implementation of sub-components (vehicle capability, driver capability, and task demand) such that redesigning one of the sub-components (e.g., to add extra complexity, to add new inputs, to adapt to low latency and response times) will not affect other sub-components. The definition of a standardized set of outputs for each sub-component ensures that other model sub-components, which are dependent on reading these outputs as an input, will not be interfered.

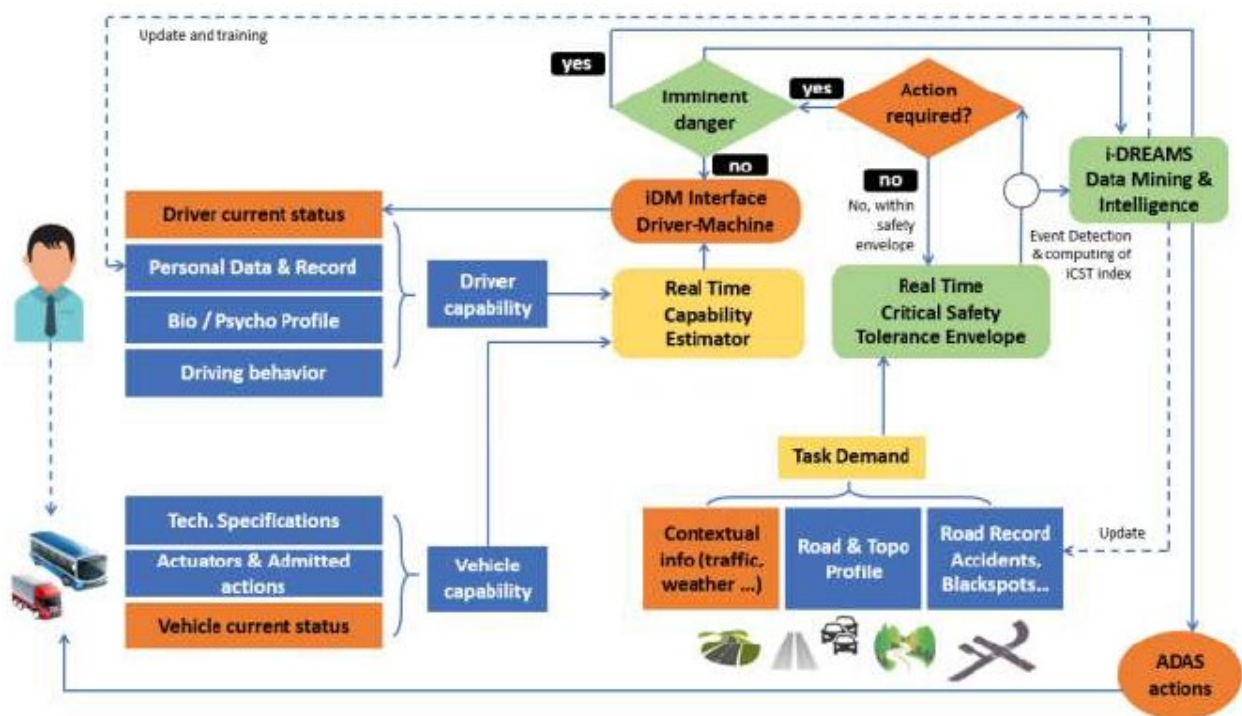

Figure 3: Methodological framework behind the *i*-Dreams platform with overview of process from raw data input streams via real-time critical Safety Tolerance Zone envelope to intervention outputs.

The *i*-DREAMS system is based on sensor data collection, integration, and real-time processing of all the parameters acquired while driving. Data from the different system components (driver capability, vehicle capability, and task demand) is collected, merged, and processed to obtain a real-time assessment of the *critical safety risk*, including when and how interventions, such as in-vehicle notifications and driver training & coaching, are initiated to keep the driver within the acceptable boundaries of the Safety Tolerance Zone envelope. The data collected from the different sensors, technologies, and questionnaires is stored in a centralized database for post-trip analysis, driver coaching, and data mining purposes.

2.1 Safety Tolerance Zone

The Safety Tolerance Zone (STZ) is the core concept of the *i*-DREAMS system, guiding the entire process of developing the *i*-DREAMS platform. As a theoretical concept, the STZ originates from Fuller's Task Capability Interface (TCI) model (Fuller 2000, 2005, 2011). In brief, this model states that for the driver to be fully in control of the vehicle and operate it safely, their capability (referred to here as coping capacity) must be balanced with the task demand (referred to here as task complexity). See Talbot *et al.* (2020) for further detail.

The STZ includes three different driving phases: normal, danger, and avoidable accident phase (Table 1). As set out in Katrakazas *et al.* (2020), the normal driving phase represents the conditions in which a crash is unlikely to occur, i.e., the crash risk is low. During this phase, the driver can successfully adapt their behaviour to meet the task demand, thus achieving a balance between coping capacity and task complexity. The danger phase is characterised by changes from normal driving that indicate that a crash may occur, therefore, the crash risk is increased. Finally, the avoidable accident phase occurs when a collision scenario develops but there is still time for the driver to intervene and avoid the crash. The need for action is more urgent than in the danger phase and if the driver does not adapt their behaviour to the current circumstances, a crash is very likely to occur.

Table 1: Phases of the Safety Tolerance Zone.

Phases of STZ	Description
Normal driving phase	Crash risk is minimal
Danger phase	Risk of crash increases as internal / external events occur
Avoidable crash phase	Crash is very likely to occur if no preventative action taken by driver

The fundamental goal of the *i*-DREAMS platform is to keep the driver in the normal driving phase for as long as possible, to prevent the transition from the danger to the avoidable accident phase and, when this is not possible, to alert the driver to take immediate corrective action to avoid the crash.

To this end, the platform combines both real-time and post-trip interventions which, respectively, aim to nudge and coach the driver. The platform is a warning-based driver assistance system, as it does not actively intervene physically in any way with the driving task. The abstract concept of the STZ is operationalised at the level of performance objectives. To estimate in which STZ phase the driver is in and which interventions should be provided, the *i*-DREAMS platform uses two modules. First, it uses the monitoring module, which takes measurements related to the context, the operator, and the vehicle, to derive the demands of the driving task and the driver's ability to cope with these demands. This module estimates in which stage of the STZ the driver is operating at any given time. More specifically, the monitoring module registers driving behaviour related to a list of performance objectives as shown in Figure 4¹ (from Brijs *et al.*, 2020 – D3.3). For these different performance objectives, events are detected. Second, the in-vehicle intervention module is responsible for keeping the

¹ Some information in Figure 4 is purposely left out for reasons of confidentiality.

driver within the normal phase of the STZ, either by providing a warning or alert during the trip (real-time intervention) or by providing feedback about the journey after the completion of the driving task (post-trip intervention). In case of real-time interventions, a different type of in-vehicle warning is being delivered to the driver depending on the kind and severity of the detected event.

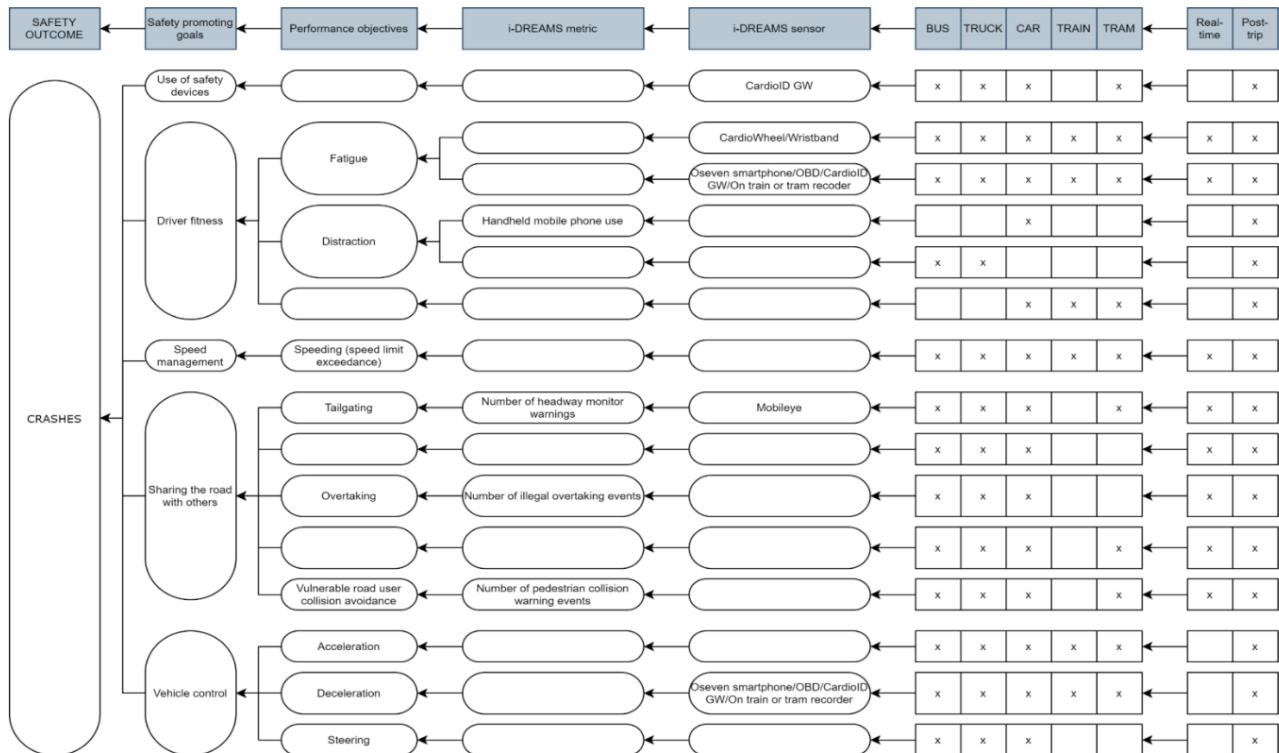

Figure 4: Safety promoting goals and related parameters.

For the real-time interventions, a nudging approach is used, since the driver has little time to think about their actions. This approach uses heuristics (i.e., mental shortcuts) and manipulation of cues within a social or physical environment to activate unconscious thought processes involved in human decision making. The delivered type of real-time intervention depends on the retrieved STZ phases. In the normal driving phase, no intervention is required. When it is detected that the driver has entered the danger phase, a warning or an indication should be given. Meanwhile, in the avoidable accident phase, a more specific intervention is required, such as an intrusive warning signal (accompanied or not by an instruction) that prompts the driver to take decisive action. With respect to the post-trip interventions, nudging is being reinforced by a coaching platform that operates outside the context of a trip.

2.2 In-Vehicle Sensors & Data Processing

The in-vehicle hardware platform especially designed for *i*-DREAMS includes both monitoring and intervention dimensions, coordinated by a central element, the CardioGateway (CardioGW), an edge-computing device that aggregates all information from the monitoring sensors, computes the STZ, and triggers the interventions in the onboard intervention device.

The monitoring dimension includes sensors targeting all the perspectives needed for the computation of the STZ phase, namely driver state, driving task complexity, and driving performance. Figure 5 illustrates which sensors are associated with each monitoring perspective, while Table 2 briefly describes each sensor component.



Figure 5: In-vehicle monitoring components.

Table 2: Description of in-vehicle sensors.

Monitoring Perspective	Sensor	Description
Driver State	CardioWheel	Acquires the electrocardiogram (ECG) from the driver's hands to continuously detect drowsiness, hands-on-wheel detection, cardiac health problems, and biometric identity recognition.
	PulseOn Wearable	Wristband measuring the Photoplethysmogram (PPG) to continuously measure the heart rhythm and heart rate variability (HRV).
Driving Task Complexity	Mobileye	ADAS collision avoidance system based on headway monitoring, including detection of vulnerable road users and traffic sign recognition.
	DashCam	Camera targeting the road environment in front of the vehicle. Recordings are triggered when certain safety-critical events occur while driving. Faces and license plates are obfuscated for privacy protection.
Driving Performance	OSeven Driver App	Installed on the driver's phone, this app provides an indicator of driver distraction, as well as harsh acceleration and breaking events. The app is also used for post-trip feedback and to nudge the drivers towards safer driving, through the <i>i-DREAMS</i> gamification platform.
	CardioGateway	Edge-computing device that records data from all input sensors, determines the STZ phase in real-time, provides interventions to the driver, and uploads trip data for analysis. It also has an embedded satellite positioning receiver (GNSS), a Fleet Management System (FMS) reader, and an inertial motion unit to detect harsh driving events (acceleration, breaking, and cornering).

To thoroughly validate the *i*-DREAMS system, both simulator and on-road field trials were carried out, targeting multiple transport modes (car, bus, truck, rail). This was possible by leveraging the in-vehicle hardware infrastructure’s flexibility and modularity, enabling the collection of an equivalent data set across the different modes. To address the particularities of each transport mode, some adaptations were made to the set of sensors, as described in Table 3. The most impacting difference is the use of the Wearable vs CardioWheel. Since the installation of CardioWheel requires some modification of the steering wheel (placing a steering wheel cover and connecting it to the acquisition module), it was deemed too intrusive to use in (private) cars, given the temporary nature of the trials. Therefore, the PulseOn Wearable was used in the car trials.

Table 3: Overview of data collection sensors per transport mode for the on-road field trials.

Car	Truck	Bus	Tram (only SIM)
Mobileye	Mobileye	Mobileye	Mobileye
Wearable	CardioWheel	CardioWheel	Wearable
Dash camera	Dash camera	Dash camera	Dash camera
CardioGateway (GPS, Inertial Sensor)	CardioGateway (GPS, Inertial Sensor, FMS)	CardioGateway (GPS, Inertial Sensor, FMS)	CardioGateway (GPS, Inertial Sensor)
i-DREAMS app	i-DREAMS app	i-DREAMS app	i-DREAMS app

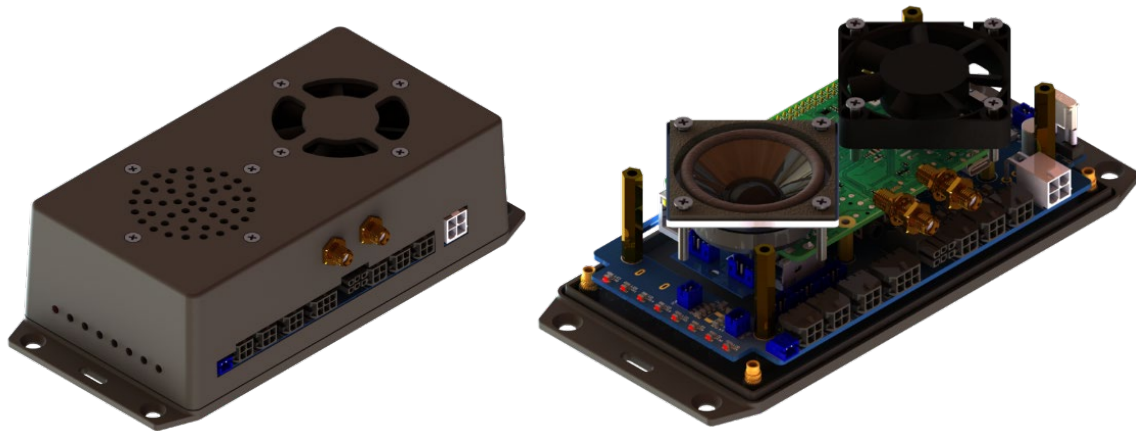

Figure 6: Final CardioGateway form-factor (external and internal views).

The CardioGW, given its central role in trip data collection, was carefully designed to be able to handle all the project’s requirements, both in terms of hardware and software. A summary of the specifications of the final hardware form-factor (see Figure 6) is shown in Table 4.

Table 4: Summary of CardioGateway hardware characteristics.

Parameter	Value
Dimensions (mm)	175 L x 80 W x 50 H
Flammability Rating	UL 94V-0
Input Voltage Range (V)	10 - 30
Max. Power Dissipation (W)	20
Connection Interfaces	1x Power (BAT, IGN, GND) 2x CAN (Mobileye + FMS) 1x DashCam 1x Intervention Device 1x LTE Antenna 1x GNSS Antenna
Audio	Built-in speaker
Mobile Network	2G, 3G, 4G
Wireless	IEEE 802.11ac Wi-Fi, Bluetooth 5.0
Positioning	GPS, GLONASS, BDS, Galileo, QZSS
CPU	Quad core Cortex-A72 (ARM v8) 64-bit SoC @ 1.8GHz
RAM (GiB)	4
Storage (GiB)	32

In terms of software, the CardioGW runs a Debian-based operating system, with application code implemented in Python. The application code is responsible for reading and distributing sensor data, running the STZ algorithm, triggering interventions to the driver, recording DashCam videos, and uploading trip data for post-trip analysis and storage. Additionally, the CardioGW software needs to keep itself up to date, using an over-the-air update mechanism, and perform system health checks and logging.

Regarding the task of reading and distributing sensor data within the CardioGW system, it should be noted that each sensor produces data with its own protocol, its own data format, and its own data rate. Moreover, data collection must be done in parallel, i.e., the system must be able to read from multiple sensors at the same time. On the other hand, data transmission is time-critical, in the sense that important messages (e.g., a collision warning) must be processed in the shortest time possible. Additionally, collected data needs to be distributed among several computing modules, which themselves produce output that needs to be sent elsewhere (e.g., to trigger a driver intervention or start a dashcam recording). To address these challenges, a data transfer format was specified, which is used by all sensor reader modules and all data processing components. An N-to-N, high-speed messaging library (ZeroMQ²) was used to distribute sensor data, using a publish/subscribe pattern. The resulting sensor data network is illustrated in Figure 7.

² <https://zeromq.org/>

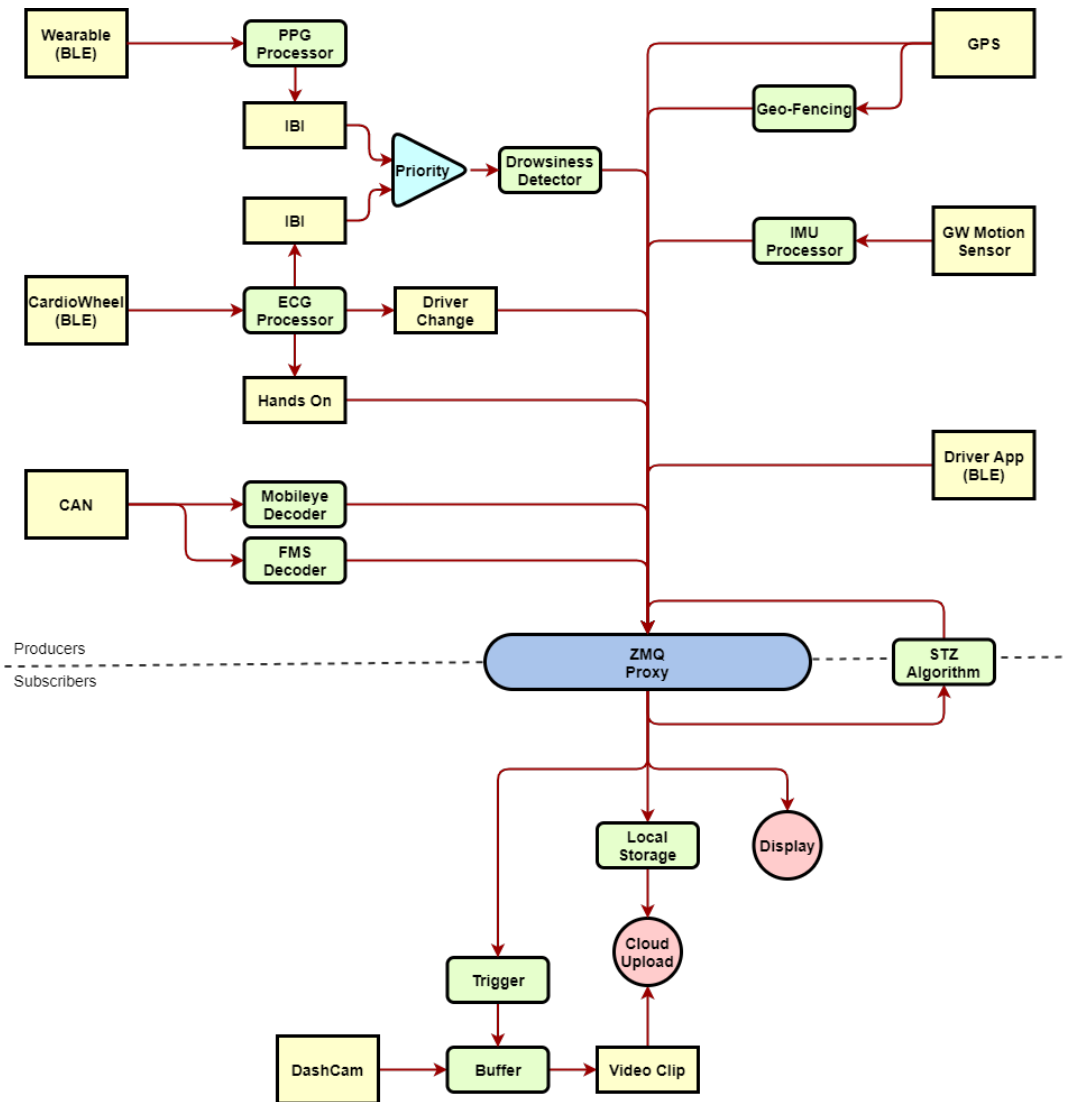

Figure 7: Data flow diagram of CardioGateway's sensor network (extracted from Lourenço et al, 2021).

2.3 In-Vehicle Assistance

In-vehicle assistance is provided by the *i*-DREAMS Intervention Device, illustrated in Figure 8. It is a customized integration of a capacitive LCD display with some complementary electronics, that communicates with CardioGateway to receive the status of the safety tolerance zone (STZ) and to provide visual and sound alerts in real-time. Additionally, it also acts as a mechanism to perform driver identification.

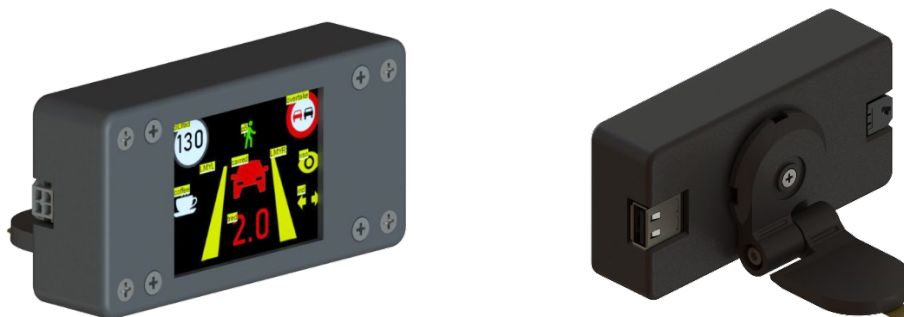

Figure 8: Intervention device (front and back views).

2.3.1 Display

The system is a complete HMI solution combining a touch-sensitive LCD screen with an onboard controller and memory, mounted on the driver's cockpit. This means that it does not require a video signal. Instead, the device can be programmed with a custom routine and pre-defined pictures and screens. These pre-defined pictures and screens can be called through a UART serial interface, which makes the device compatible with a wide range of other controllers and devices, including the CardioGateway. Using simple serial messages to control the display device instead of a video signal also reduces processing and graphical load on the CardioGW.

Another advantage of using a complete solution with internal controller is that the HMI device can run its own routine without a connection to other controllers. Within the *i*-DREAMS system, this is especially important during the start-up phase, right after the vehicle's ignition switch has been turned on. The Intervention Device boots up almost instantly and prompts the driver with a message to confirm their ID before the bootup sequence of CardioGW is fully completed, as depicted in Figure 9. Once the welcome screen is displayed, the Intervention Device waits for the *i*-DREAMS gateway to boot up. When communication has been established, the real-time interventions GUI is loaded. Otherwise, the intervention device will be deactivated.

On the CardioGW side, a software controller module was developed. This module is part of the data distribution network, receiving messages from the STZ algorithm, speed limit information, and traffic signs, which then activate the appropriate visualizations on the display. This controller module also triggers the warning sounds associated with each intervention situation, using the audio speaker on the CardioGW.

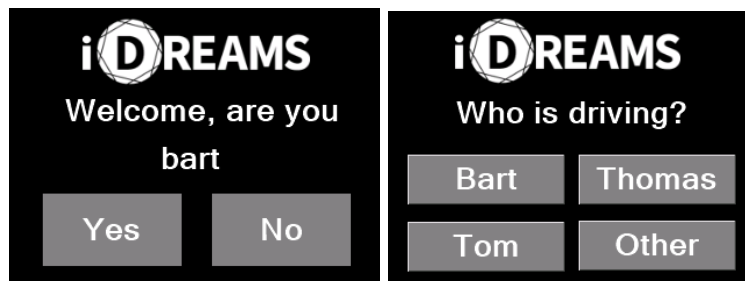

Figure 9: Driver identification GUI screens.

2.3.2 Real-time interventions

The approach for the design of a real-time intervention graphical user interface (GUI) was to use a main page where the driver is presented with relevant, non-safety-critical information in real-time (see Figure 10). Such system includes information about the current status of safety monitoring systems, traffic sign, and speed limit information, as well as nudging mechanisms that promote safer driving.

Interventions that are time-critical and demand immediate action have a dedicated view and take over the entire screen. Usually, they are also accompanied by an auditory alert. Changes in traffic laws, such as a change of speed limit, also trigger a temporary popup on the entire screen, unless more important information is currently available. An overview of the different symbols that can be exhibited on the main page is provided in Table 5, while Table 6 shows an overview of the possible dedicated views for time-critical warnings.

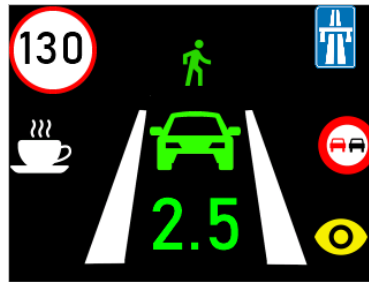



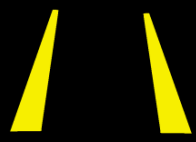



Figure 10: Main page of real-time interventions GUI (extracted from Lourenço et al.,2020).

Table 5: Real-time intervention GUI: Main page symbol overview (extracted from Lourenço et al.,2020).

Symbol	Meaning
	Headway Monitoring: Vehicle detected ahead.
	Headway Monitoring: Vehicle detected ahead and driving at a safe distance. Time headway is displayed.
	Headway Monitoring: Vehicle detected ahead, time headway to the vehicle is unsafe. Time headway is displayed. When time headway is below the first threshold, a static red car is displayed. When a second threshold is passed, the red car symbol is blinking.
	Lane departure monitoring: No road markings detected.
	Lane departure monitoring: Road marking detected.
	Lane departure monitoring: Lane departure warning on the right-hand side is active. Crossing right-hand side markings without turn indicator usage.















Symbol	Meaning
	Lane departure monitoring: Lane departure warning on the left-hand side is active. Crossing left-hand side markings without turn indicator usage.
	VRU monitoring: vulnerable road user detected (pedestrians, bicycles, motorbikes).
	Speed limit indication and monitoring: displays the latest speed limit traffic sign.
	Speed limit indication and monitoring: displays the latest speed limit traffic sign. Current speed is above the speed limit.
	Fatigue and sleepiness monitoring: Fatigue is detected, first stage.
	Fatigue and sleepiness monitoring: Fatigue is detected, second stage. Symbol is flashing on and off.
	Illegal overtaking monitoring: A no-overtaking sign has been detected.
	Visibility: Poor visibility
	Traffic Sign Recognition: Certain traffic signs can be recognized and displayed on the main screen.

Table 6: Overview of the dedicated views for time-critical warnings (extracted from Lourenço et al., 2020)..

View	Meaning
	Headway Monitoring: Forward Collision Warning. Symbol is blinking
	VRU Monitoring: Pedestrian Collision Warning. Symbol is blinking
	Speed Limit indication and monitoring: There are 2 stages of over speeding: During the first stage, the symbol is displayed statically for 1s. During the second stage, the symbol is blinking for 1s.
	Fatigue and sleepiness monitoring: Shown for 1s when the first stage of fatigue is first detected.
	Fatigue and sleepiness monitoring: Shown for 1s when the second stage of fatigue is first detected.
	Illegal overtaking monitoring: An illegal overtaking action is currently being performed.

2.4 Post-trip Personalized Feedback

An important innovation of the *i*-DREAMS system is the use of personalized feedback to the drivers, leveraged by post-trip data analysis and scoring, and taking advantage of a gamified approach to nudge and coach the drivers to adopt safer driving habits and behaviours. The first step to accomplish this is to upload trip data from the CardioGateway to a cloud environment, where data processing and aggregation takes place. Afterwards, for each trip and driver, safety scores are computed, which are then used to provide feedback to the drivers, via both the *i*-DREAMS Driver App and a web dashboard.

2.4.1 Cloud Components and Data Flow

The *i*-DREAMS cloud architecture consists of several input, output, and processing (server) components, as shown in Figure 11. Different components communicate with each other through a REST API interface.

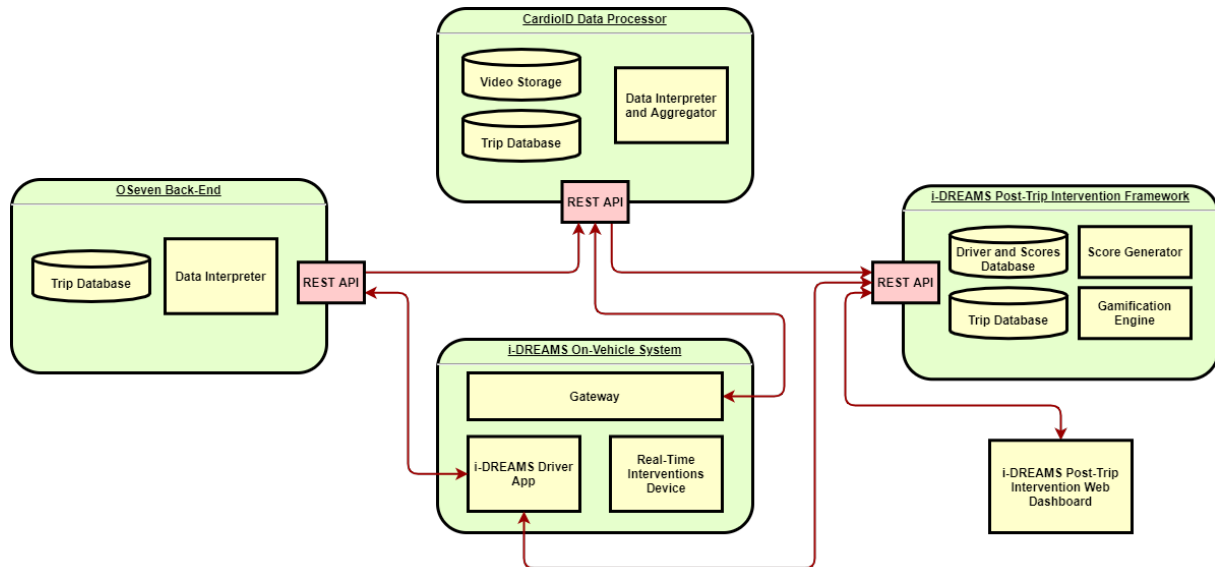

Figure 11: *i*-DREAMS cloud components and data flow (extracted from Lourenço et al., 2021).

The *i*-DREAMS platform consists of the following input components:

- ***i*-DREAMS on-vehicle system**: collects real-time data relevant for real-time interventions and stores a part of this data (on the CardioGateway) to be sent through to the *i*-DREAMS data processor.
- ***i*-DREAMS driver app**: integrates the O7SDK that collects data from smartphone sensors (e.g., GPS, accelerometer, gyroscope) during a trip, that is used for real-time and post-trip interventions and sends it to the OSeven backend for processing after the end of each trip.
- **OSeven backend**: processes the data collected from the *i*-DREAMS app (O7SDK) together with map related data and calculates driving metrics and scores, which are finally made available to the *i*-DREAMS data processor. It also provides a service to derive speed limits and speeding events to the post-trip intervention framework.

The *i*-DREAMS platform consists of the following output components:

- ***i*-DREAMS real-time intervention device**: visually shows real-time interventions to the driver.
- ***i*-DREAMS driver app**: shows scores and other gamification elements to the driver (post-trip intervention).
- ***i*-DREAMS post-trip intervention dashboard (Web)**: allows the company coach and manager to analyse behaviour evolution of the drivers. The *i*-DREAMS controller also uses the dashboard to configure gamification functionality for each trial group.

The *i*-DREAMS platform consists of the following processing/backend components:

- ***i*-DREAMS data processor**: receives data from the *i*-DREAMS on-vehicle system and the *i*-DREAMS driver app, processes and stores it. It exposes an API to the *i*-DREAMS post-intervention framework, which can then get the necessary data from it. Each time new trip data is available, the post-trip intervention backend gets notified and can synchronize this trip data.

- ***i*-DREAMS post-trip intervention framework**: contains trip information and a database with scores for all relevant performance objectives, which it generates from the data obtained from the *i*-DREAMS data processor. The driver app and the web dashboard use its API for their operations.

The *i*-DREAMS post-trip intervention framework provides the driver with scores on a set of performance objectives, grouped into safety promoting goals, as shown in Figure 12.

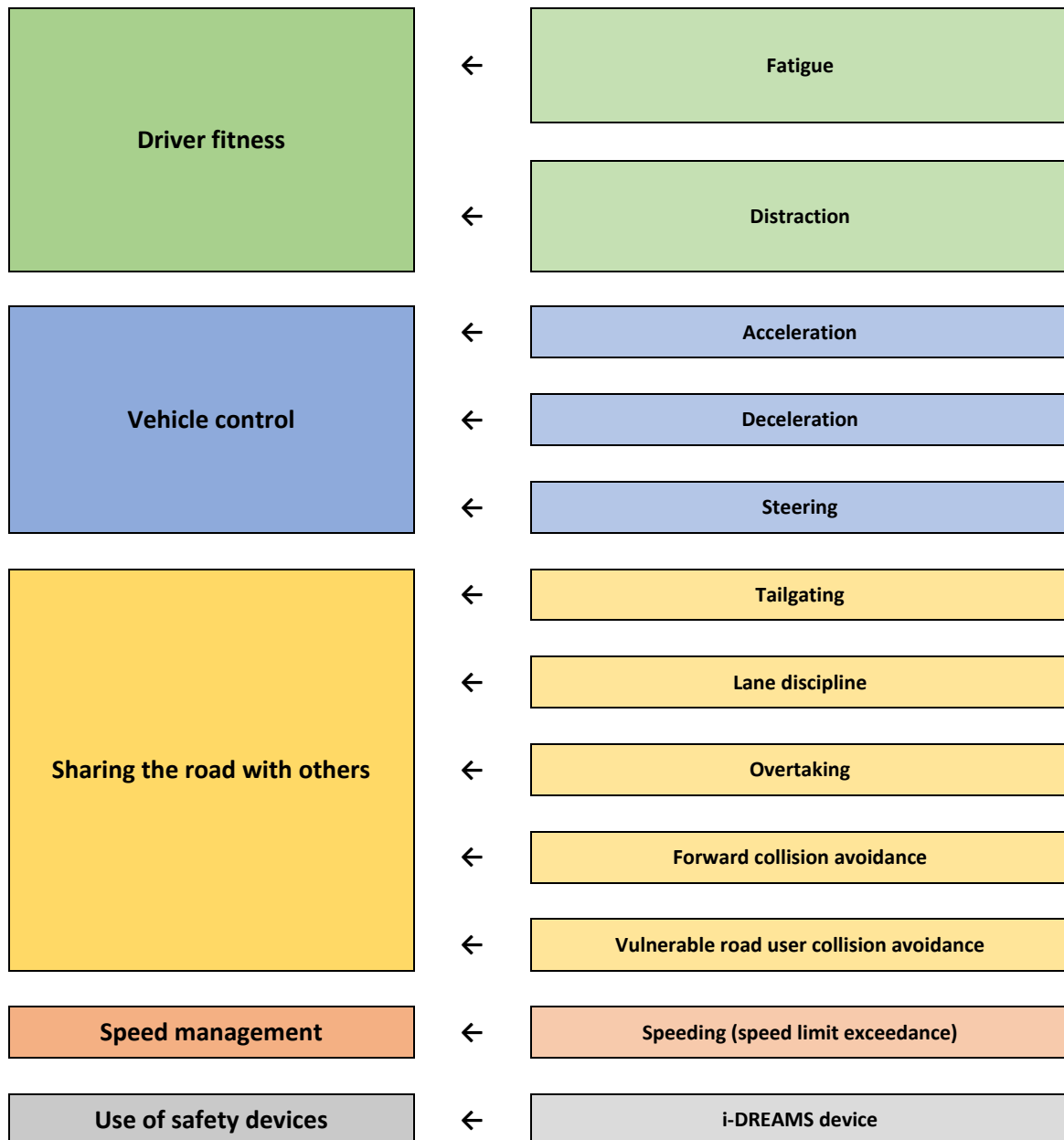

Figure 12: Safety promoting goals and performance objectives (extracted from Vanrompay, 2020).

The post-trip intervention framework needs to calculate the scores for these performance objectives. It obtains data from the *i*-DREAMS data processor, which has cleaned, interpreted, and aggregated the data it had received from the different input components. The post-trip intervention framework receives general trip data (start and end time, location trace, distance, etc.) and pre-processed data. The former will be stored in the trips repository, and the latter is fed into the scores generator, which will generate scores for the different performance objectives and store them in the scores database.

Scores data is the starting point for the gamification engine. These scores are shown to the user and are the basic metric by which a user can track their progress for a given performance objective. The scores also drive forward the other gamification elements:

- A Leaderboard which ranks drivers according to their overall safety score.
- Goals taken up by drivers trying to achieve a target score within a given time or distance.
- Badges earned when achieving goals for specific performance objectives.
- Credits associated with achieving a good score.

Supporting information, like advantages and disadvantages of certain behaviour, as well as tips to achieve a specific goal are also managed by the gamification engine.

Altogether, the post-trip intervention framework and its gamification engine manage the gamification experience for the user and provide all necessary information to the *i-DREAMS* app through its REST API.

2.4.2 *i-DREAMS* App: technical overview

The development approach and architecture focused on the following non-functional requirements:

- Use of mainstream technologies: Kotlin, Swift and REST are popular, extensive, and well-supported technologies for app development. Kotlin libraries, like *moxy* for realizing the MVP (model-view-presenter) design pattern, or *dagger* for dependency injection, are well-established. For iOS, we integrate PODS-like *XGCLogger* for easy logging and debugging, *R.Swift* to get strong autotyped resources, and *ReactiveCocoa* for reactive functional programming.
- Content genericity and adaptability: Gamification features are highly configurable. The driving behaviour parameters (safety promoting goals and performance objectives) could be changed or extended in the future. The app dynamically decides which content to load based on the set of behaviour parameters that are active for the user.
- Use of open data: for showing map tiles, we used OpenStreetmap, which is non-proprietary data.
- Flexible, iterative, traceable development: agile Scrum development, using a development tool stack that is standard in industry.

The *i-DREAMS* app was developed using an agile (Scrum) methodology, in which functionalities are described in stories, selected, and grouped in sprints of 2 weeks. Each sprint represents an iteration in the development process. In this way, development was efficient, flexible, and traceable. The following tools supported this process:

- Jira: management of Scrum boards which contain the stories and sprints.
- Confluence: documentation of implementation decisions, API and stories.
- Gitlab: code repository tool.
- Slack: for daily and efficient communication between team members.
- GitFlow: as a basic branching approach for git.
- CI/CD: continuous integration of code via GitFlow, and Docker-based deployment in a development, test, and production environment.
- Android Studio for Kotlin code implementation and Xcode for iOS.

The *i*-DREAMS Android app was developed in the Kotlin programming language, which is a state-of-the-art language and is by now used by most Android app developers. The iOS version of the app was developed using Swift, which is easier to understand and more type safe than Objective C, making it the choice for efficient and traceable app development in the Apple ecosystem. For communication with the backend, a REST API is provided (documented in Confluence), with calls that are tailored to the functionalities needed in the app, improving communication efficiency and processing needs on the client (smartphone).

The *i*-DREAMS app is available in 5 languages (Dutch, Greek, Portuguese, English and German) and can be downloaded from the respective Android and iOS app stores (in Belgium, Germany, UK, Portugal, and Greece). Access to the *i*-DREAMS app is managed by a user login. This login is provided by means of a 'magic link' sent to the user via e-mail by an *i*-DREAMS system administrator. A login link recovery mechanism is in place in case the user has accidentally logged out of the App and has lost the original magic link. During installation of the *i*-DREAMS app, the user needs to provide user permissions (e.g., enable location services, Bluetooth, physical activity, Wi-Fi / Mobile data, battery saving), accept the *i*-DREAMS App's Terms and Conditions, and is informed about the *i*-DREAMS Privacy Policy. More technical documentation and detailed screenshots about the *i*-DREAMS app can be found in Vanrompay et al (2020), *i*-DREAMS Deliverable 4.5.

2.4.2.1 OSeven SDK for *i*-DREAMS App

The O7SDK for Android and iOS has been developed and is continuously optimized, to achieve the optimum balance of recording accuracy and battery consumption. Therefore, the data recording does not run 24/7 in the background, but it is regularly activated by the operating system to collect data for a few seconds, to determine if the user is in a vehicle and is driving. This process is called "Driving Detection". If the O7SDK verifies that (a) the user is in driving status and (b) the logged in user matches with the user that is logged in to the *i*-DREAMS on-vehicle system, trip recording starts. Otherwise, the data collection procedure stops, and the SDK is in a paused state until the next time it is activated again. Trip recording starts automatically within the first minutes of driving and will end 5 minutes after the end of driving.

Real time mobile use detection (RTMU)

The library for real time mobile use detection is designed to be battery friendly and thread safe. The algorithm collects values from the smartphone sensors in high frequency to accommodate the real-time detection of mobile use. The detection algorithm does not rely on any specific permission that could jeopardise the user's privacy (access to the call registry, access to messages etc.). The algorithm analyses high frequency data from the device's sensors looking for patterns that indicate when a user interacts with their smartphone e.g., to answer a call, text a message, or browse the internet.

***i*-Dreams app and the *i*-DREAMS on-vehicle system communication module**

This module facilitates the communication between the driver's app and the on-vehicle system using the Bluetooth Low Energy (BLE) protocol. More precisely, the module covers two functionalities: (a) It checks to see if the currently logged in app user matches with the currently logged in user of the on-vehicle system. If this is true, it allows trip recording, otherwise it prohibits it. This functionality is required so that the app records only the trips where the app owner is driving a car that is participating in the experiment. All other cases where the app owner is a passenger or is driving a car that is not participating in the experiment will not be recorded; (b) It forwards to the on-vehicle system in real-time events of mobile use detection raised by the RTMU library. After that, the *i*-DREAMS on-vehicle system is responsible for

presenting a visual and auditory alert to the user via the *i*-DREAMS real-time intervention device.

Open Street Maps infrastructure

The required infrastructure to utilize map data from Open Street Maps (OSM), such as speed limits and addresses for trip start / end, has been developed in the O7PLATFORM to provide a reliable tool for the visualization of the trip, and also to have access in a high volume of location-based information that may be useful in a driving behaviour analysis application such as *i*-DREAMS. This is a very important component in the *i*-DREAMS project, as the costs of the commercial map providers (e.g., Google Maps, Here Maps) are very high and they would impose a significant risk in the commercialization of the *i*-DREAMS product.

Route identification algorithms are applied to compute the actual vehicle route given a collection of "noisy" GPS coordinates, and then the maximum speed limits of the identified road segments are retrieved by looking these up in the OSM database or, in case these are not available, by computing them from the type of road and country of origin.

Speed limits API

The B2B interface of OSeven has been extended to provide a new secure web service endpoint to request road segment speed limits given a list of geographical coordinates representing a vehicle's route.

2.4.3 *i*-DREAMS App: Structure and Functionalities

The *i*-DREAMS app contains the following functionalities, of which the flow is shown in Figure 13:

- *Scores*: an overview of the scores for each safety promoting goal and performance objective that is activated for a driver.
- *Trips*: a list of trips performed by the driver
 - o Trip scores: an overview of the scores for each safety promoting goal and performance objective for a selected trip of the driver.
 - o Trip on map: a GPS trace representation of a selected trip on a map, together with the events corresponding to performance objectives that happened on that trip.
- *Forum*: messages that are sent to the driver or group of drivers.
- *Settings*: Privacy policy, terms & conditions.
- *Pros-cons*: a list of advantages and disadvantages of certain driving behaviours related to specific performance objectives.
- *Tips*: a list of coping tips to improve driving behaviour related to specific performance objectives.
- *Goals and badges*:
 - o Completed goals: a list of goals for specific performance objectives that were successfully reached by the driver.
 - o Open goals: a list of goals for specific performance objectives that were taken up by the driver and on which the driver is currently working.
 - o New goals: a list of goals for specific performance objectives that are new and which the driver can take up.
- *Leaderboard*: a score-based ranking of drivers in a group.

- *Survey*: the drivers can improve their knowledge about chosen safety promoting goals by filling in questionnaires.
- *Shop*: the driver can use earned credits to buy items in the shop.

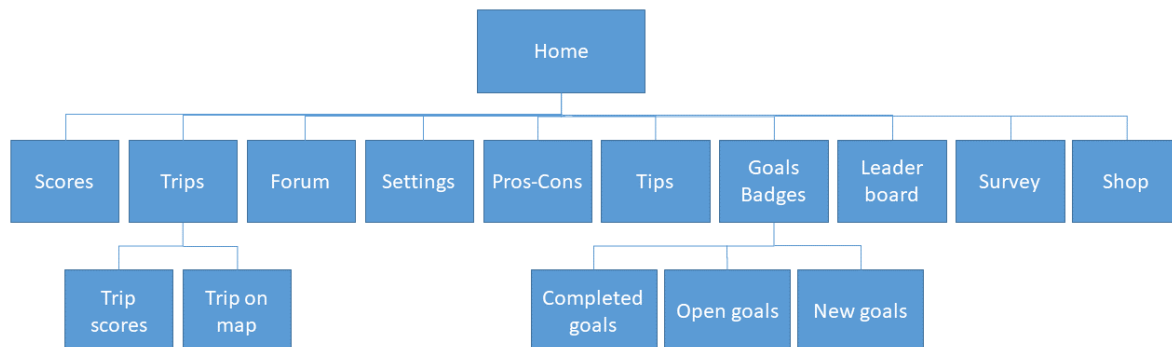

Figure 13: *i-DREAMS* app functionalities (extracted from Vanrompay et al, 2020)

In the remainder of this section, the most important screens of the app are shown and explained. For a full overview of functionalities and screens, we refer the reader to *i-DREAMS* Deliverable 4.5.

2.4.3.1 *i-DREAMS* app: home screen and scores

The home screen allows the driver to access all activated gamification functionalities (see Figure 14, left). The menu items in the bottom menu bar are always activated: home, trips, scores, forum/messages, and settings, and this menu bar is visible in every screen of the app, allowing the driver to quickly navigate to each of these functionalities. The yellow-black tiles in the home screen are only enabled when their corresponding gamification features are activated for the psychological profile of the driver. For example, a driver that is in precontemplation phase will only see pros & cons and coping tips enabled, but the leaderboard and other tiles will be greyed out. The scores screen shows the scores of the safety promoting goals and their performance objectives for the driver (see Figure 14, right). These scores are aggregated according to the time interval the driver can choose on top of the screen.

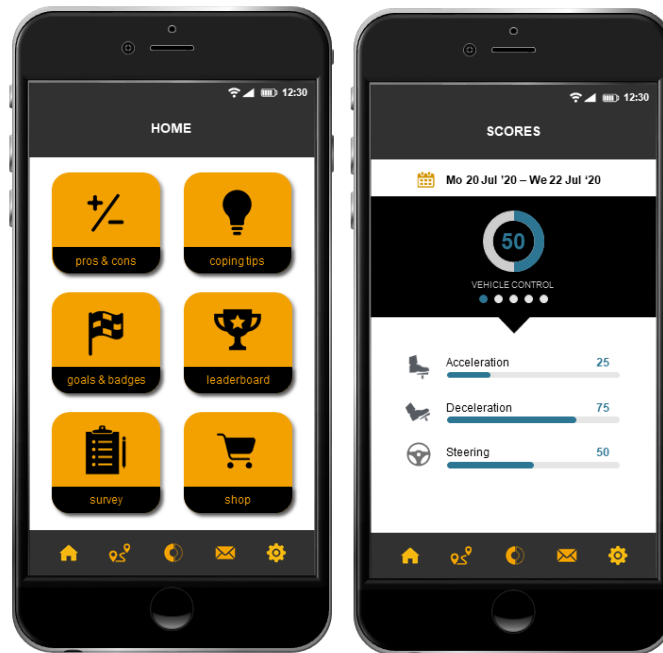

Figure 14: i-DREAMS app home screen (left) and scores screen (right), (extracted from Vanrompay et al, 2020).

2.4.3.2 i-DREAMS app: trips

By navigating to the trips screen (see Figure 15), the user sees a list of the trips that were performed for the chosen date interval. Clicking on a trip shows basic information about the trip (date, time, duration, distance), and the scores the driver obtained in the selected trip for the safety promoting goals and their performance objectives. A trip can also be visualized on a map, showing the GPS trace and the events that happened during the trip. By clicking on an event, more information about the event is shown, including a video, if available.

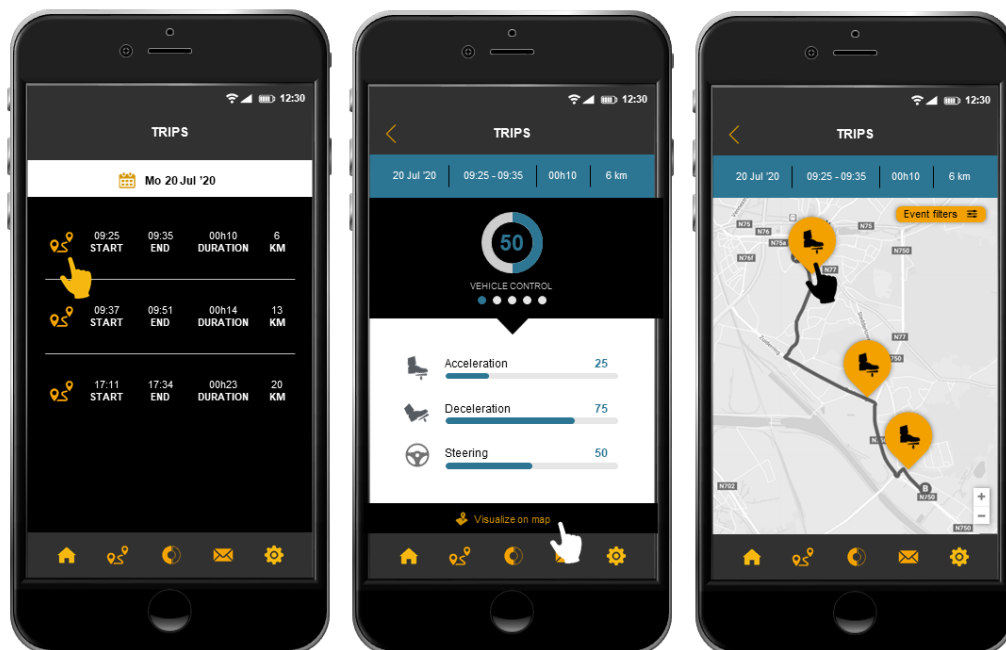

Figure 15: i-DREAMS app: trips (extracted from Vanrompay et al, 2020).

2.4.3.3 i-DREAMS app: tips and pros & cons

Coping tips and pros & cons are information elements that help the drivers in improving their driving behaviour (see Figure 16). A driver can navigate through these items that are grouped according to safety promoting goals and are tagged with the performance objective they belong to. The information items consist of a textual description and an optional picture or video. The driver can like or dislike a tip, pro or con, and provide feedback to the project leader about the content of the item.

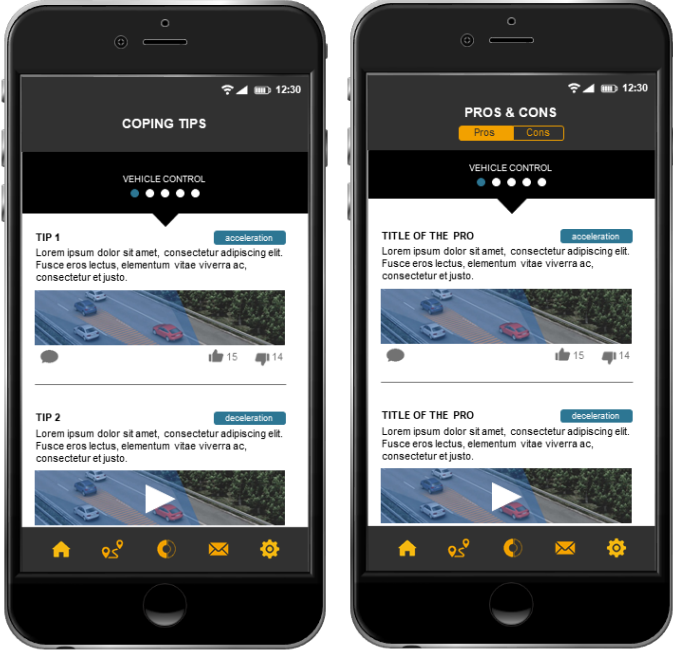

Figure 16: i-DREAMS app: coping tips (left) and pros & cons (right) (extracted from Vanrompay et al, 2020).

2.4.3.4 i-DREAMS app: leaderboard

The leaderboard shows a ranking of the drivers who are part of a group in a trial group, based on the aggregated safety score they obtained (see Figure 17). An indication of change in ranking is given as well.

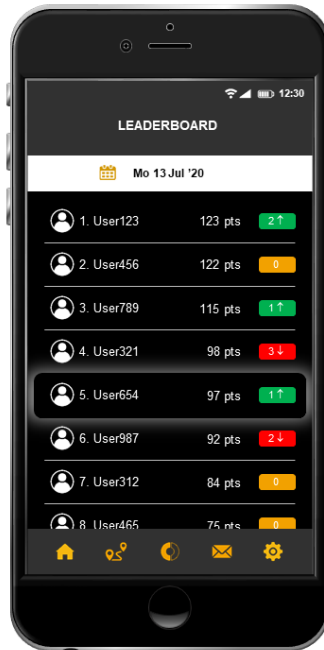

Figure 17: i-DREAMS app: leaderboard (extracted from Vanrompay et al, 2020).

2.4.3.5 i-DREAMS app: goals and badges

The goals and badges page lists the completed, open, and new goals available to the driver (see Figure 18). Goals are grouped according to safety promoting goals and are obtained by driving a specified distance with a certain score. The driver can check their progress on open goals and take up new goals. If a driver succeeds in a set of goals for a safety promoting goal, they receive a badge (bronze, silver, gold, and platinum, in increasing order of difficulty).

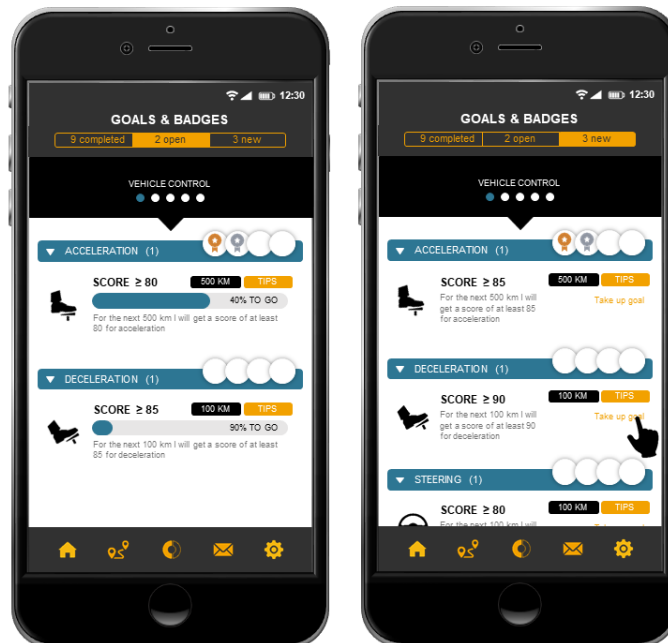

Figure 18: i-DREAMS app: goals and badges (extracted from Vanrompay et al, 2020).

2.4.3.6 i-DREAMS app: shop and survey

The drivers can exchange obtained credits for items in the shop and fill in surveys to extend their knowledge concerning safety promoting goals (see Figure 19).

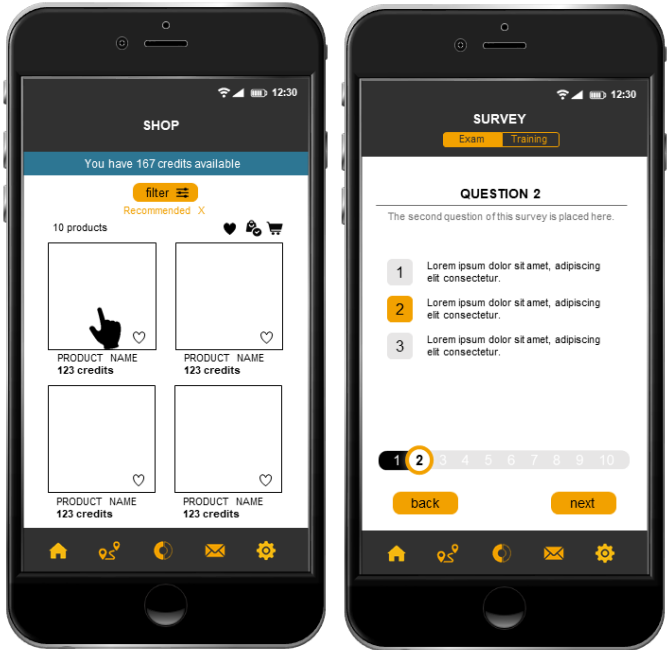

Figure 19: i-DREAMS app: shop (left) and survey (right) (extracted from Vanrompay et al, 2020).

2.4.3.7 i-DREAMS app: Forum and messages

The forum allows the project leader to communicate with drivers, where messages can be responded to and liked (see Figure 20).

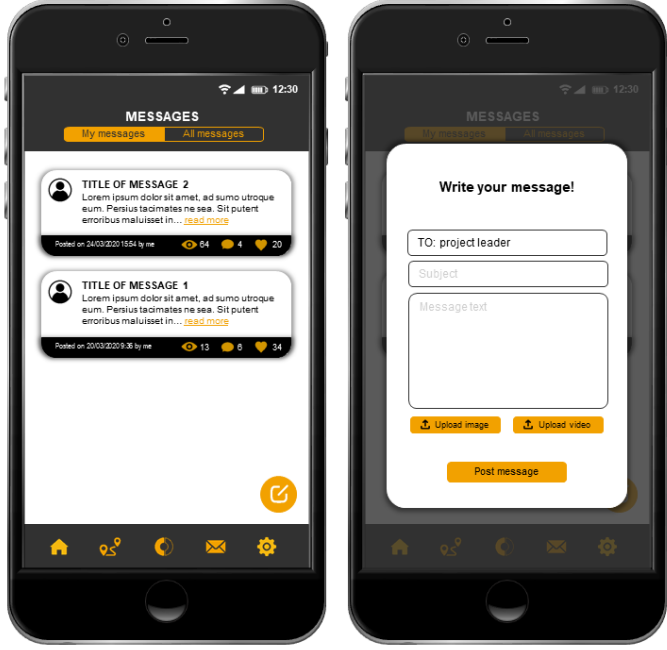

Figure 20: i-DREAMS app: Forum and messages (extracted from Vanrompay et al, 2020).

2.4.4 *i*-DREAMS Dashboard: Technical Overview

The *i*-DREAMS web dashboard uses *Angular* as a framework for implementation, and a RESTful API for communication with the backend. The development approach and architecture focused on the following non-functional requirements:

- Use of mainstream technologies: *Angular* and REST are the most popular, extensive, and well-supported technologies for web development. *Angular* libraries like *D3* and *Chart.js* for visualization of charts are well-established. For web-based map visualization, *Leaflet* was used.
- Content genericity and adaptability: Gamification features are highly configurable. The driving behaviour parameters (safety promoting goals and performance objectives) could be changed or extended in the future. The website dynamically decides which content to load based on the set of behaviour parameters per trial group, a group being a company or field trial unit participating to *i*-DREAMS.
- Use of open data: for showing map tiles, we used OpenStreetmap, which is non-proprietary data.
- Flexible, iterative, traceable development: agile Scrum development, using a development tool stack that is standard in industry.

The web dashboard was developed using an agile (Scrum) methodology, in which functionalities are described in stories, selected, and grouped in sprints of 2 weeks. Each sprint represents an iteration in the development process. In this way, development was efficient, flexible, and traceable. The following tools supported this process:

- Jira: management of Scrum boards which contain the stories and sprints.
- Confluence: documentation of implementation decisions, API and stories.
- Gitlab: code repository tool.
- Slack: for daily and efficient communication between team members.
- GitFlow: as a basic branching approach for git.
- CI/CD: continuous integration of code via GitFlow, and Docker-based deployment in a development, test, and production environment.
- IntelliJ IDEA: for code implementation.

More technical information about the *i*-DREAMS post-trip intervention web dashboard can be found in *i*-DREAMS Deliverable 4.6: A web platform for personalized goal setting, tips & tricks, and social gamification.

2.4.5 *i*-DREAMS Dashboard: Structure and Functionalities

The *i*-DREAMS web dashboard enables goal setting and social gamification (feed and feed forward). Fleet managers/operators can set and receive goals and configure or consult a set of gamification features to improve driver behaviour in a sustainable way. Based on the safety driver performance of the individual, new personalized goals are communicated to the driver on the smartphone app and tips, tricks and rewards are provided to achieve those goals. The fleet manager/operator is also able to see the safety driver performance in relation to fellow drivers. The dashboard contains the following functionalities, of which the site map is shown in Figure 21:

- **Drivers:**
 - o Individuals: an overview of drivers within a project, with basic metrics like number of trips for each driver. Also, driver administration is available in this screen.
 - o Groups: functionality to view, edit and create groups of drivers.
- **Leaderboards:** ranking of drivers in a project according to scores.
- **Results:**
 - o Trips: a listing of the trips performed by specific drivers.
 - Trip score: detailed view of the scores on performance objectives for a trip of a driver.
 - Map: view of the trip and the events related to performance objectives on a map.
 - o Scores: time evolution of group-average and driver-specific scores for performance objectives and safety promoting goals.
 - o Reports: possibility to generation PDF reports containing driver or group performance.
- **Gamification:**
 - o Tips: view, edit and create a list of coping tips to improve driving behaviour related to specific performance objectives.
 - o Pros/cons: view, edit, and create a list of advantages and disadvantages of certain driving behaviour related to specific performance objectives.
 - o Goals/badges: view, edit, and create a list of goals for specific performance objectives for a group of drivers.
 - o Credits: configure credits in the project.
 - o Shop: configure items in the shop for a project.
 - o Survey: list, edit and create questions for use in surveys performed by drivers.
 - o Phases: configuration of available functionalities in the *i-DREAMS* app given the different psychological profiles of drivers.
- **Forum:** functionality to communicate with drivers by sending messages.
- **Contact us:** *i-DREAMS* information and contact details.

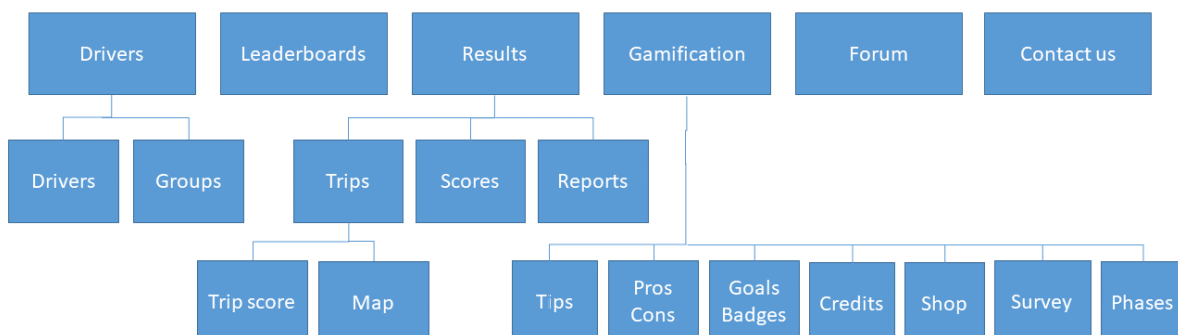

Figure 21: *i-DREAMS* web platform site map (extracted from Vanrompay et al 2020).

In the remainder of this section, the most important screens of the web platform are shown and explained. For a full overview of functionalities and screens, we refer to the reader to *i-DREAMS* Deliverables 4.6 and 4.7.

2.4.5.1 Drivers: individuals and groups

The drivers screen (Figure 22) allows for administration of, and viewing information on, individual drivers and groups of drivers. For an individual driver, we show the transportation type they are driving, their behavioural (psychological) phase, the group to which the driver belongs, the number of credits obtained, the badges gathered, and basic driving information (number of trips, time driven, distance driven). Drivers can be added or deactivated, and transport type, behavioural phase, and driver personal information can be edited here.

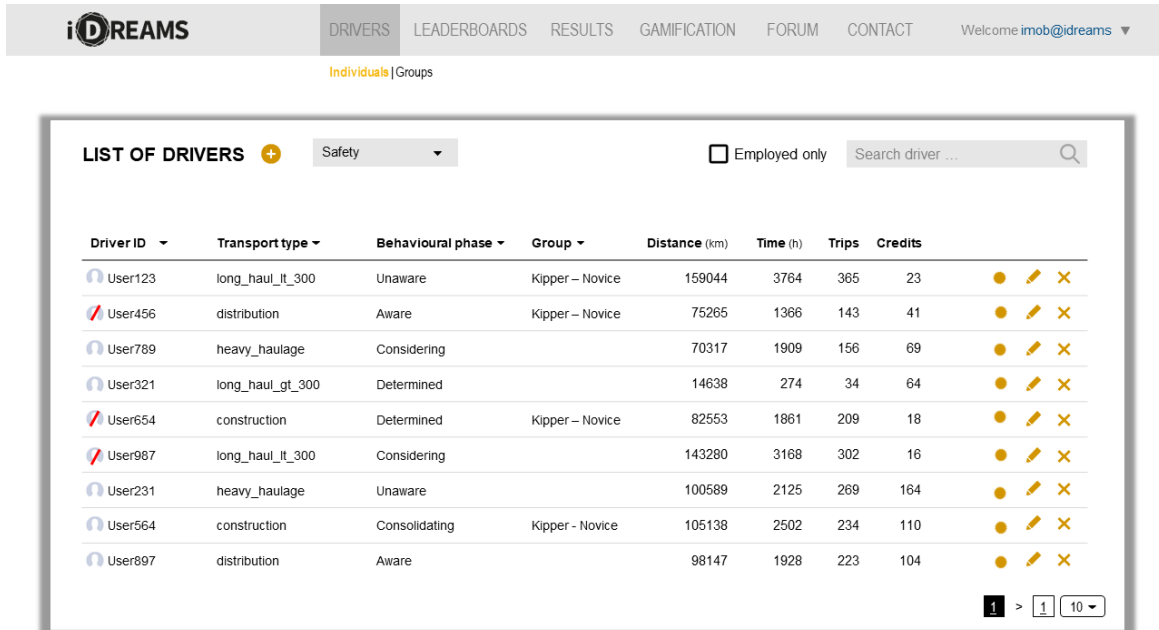

Figure 22: i-DREAMS web platform: list of drivers (extracted from Vanrompay et al 2020).

The groups screen (Figure 23) gives a list of the available groups of drivers in the project, with the possibility to create, edit and delete a group, and to see the detailed information about a group.

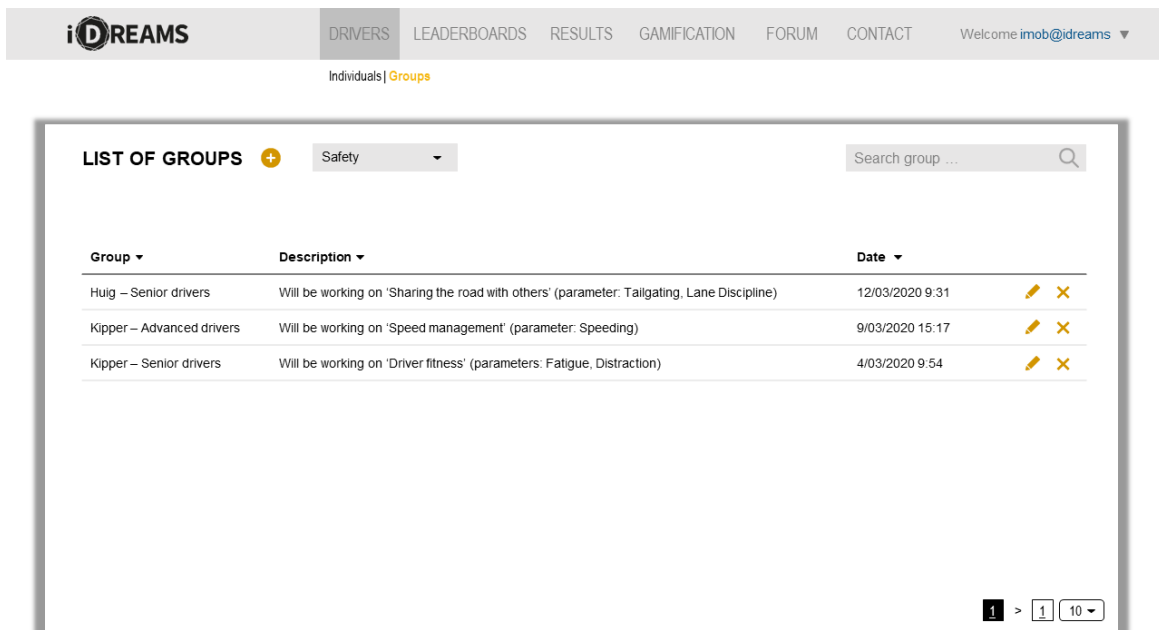

Figure 23: i-DREAMS web platform: list of groups (extracted from Vanrompay et al 2020).

Group details are shown in Figure 24. The group consists of several group members (drivers), who are working on a set of safety promoting goals and performance objectives.

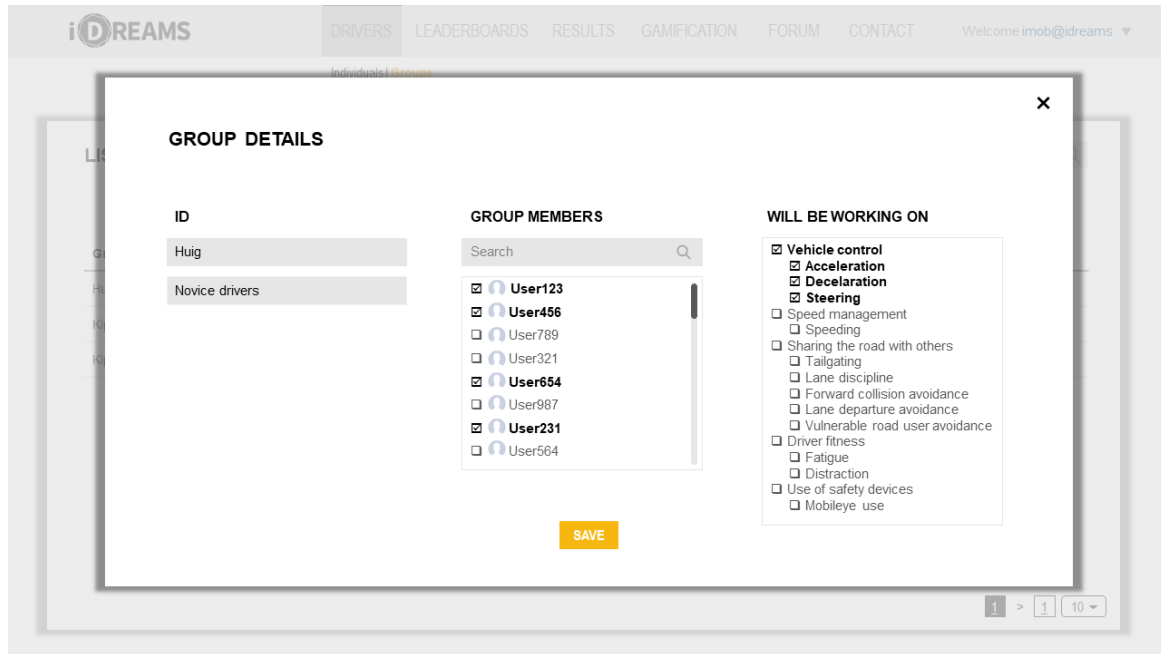

Figure 24: i-DREAMS web platform: group details (extracted from Vanrompay et al 2020).

2.4.5.2 Leaderboards

The leaderboards screen shows a ranking of drivers (with their score and position change in the ranking). The leaderboard can be filtered according to target audience, behavioural phase, and the ranking position can be changed according to different timings.

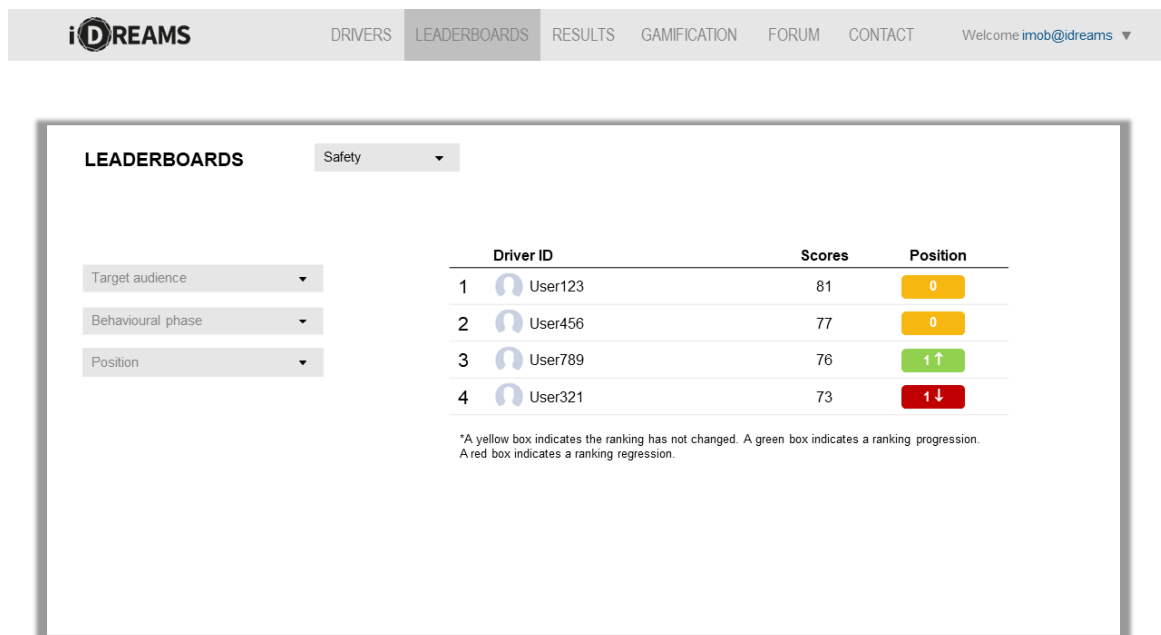

Figure 25: i-DREAMS web platform: leaderboard (extracted from Vanrompay et al 2020).

2.4.5.3 Results: trips

The trips screen (Figure 26) gives a listing of the trips performed by a selected driver. By clicking on a trip in the list, the scores and number of events are shown for each performance objective.

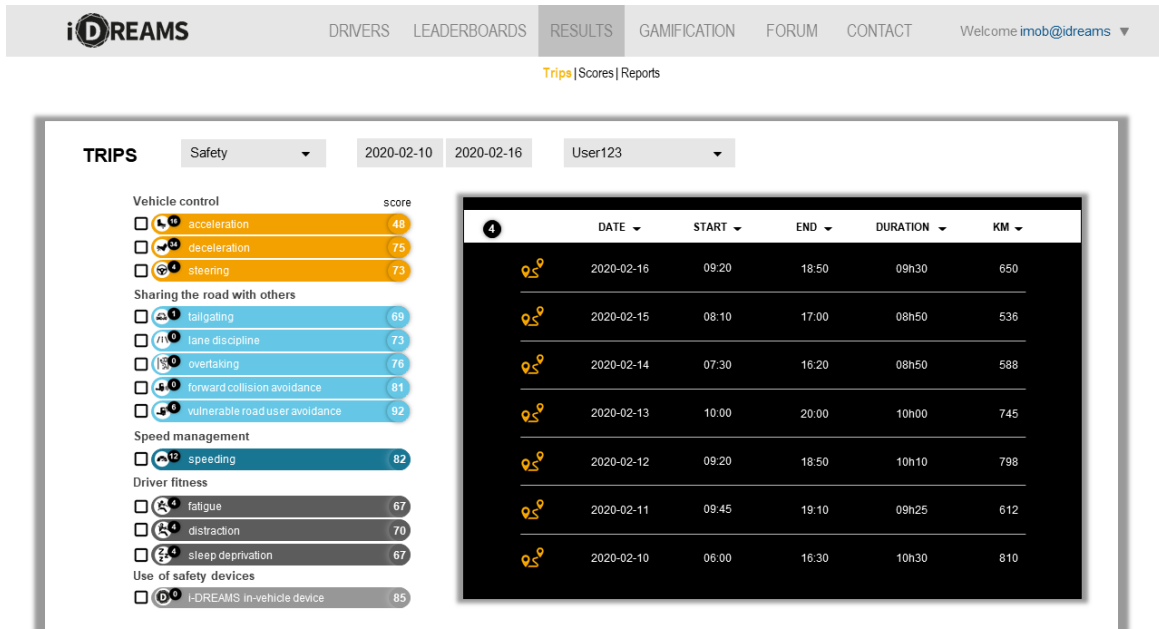

Figure 26: i-DREAMS web platform: results – trips (extracted from Vanrompay et al 2020).

By clicking on the route icon of a specific trip, a trace of the trip with performance objective events as markers on the trace is shown in a map (Figure 27). Events can be filtered according to performance objective, and by clicking on an event, detailed information (and where available, a video) is shown.

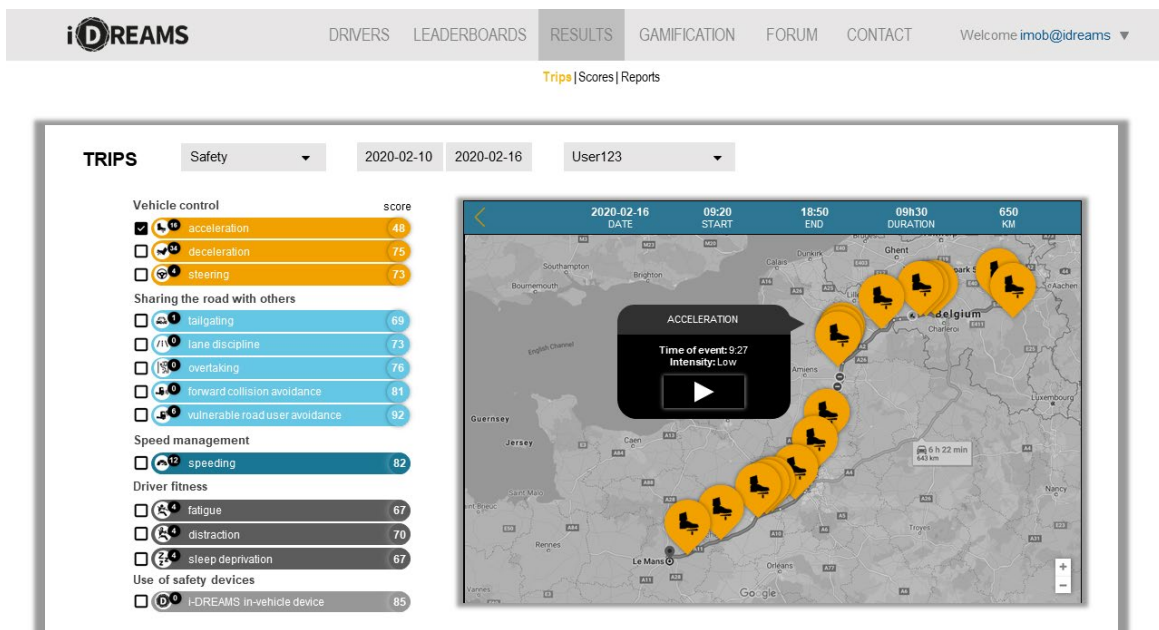

Figure 27: i-DREAMS web platform: results - trip details (extracted from Vanrompay et al 2020).

2.4.5.4 Results: scores

The scores screen (Figure 28) shows the scores for the different performance objective (per driver or averaged over all drivers in a trial group). The time interval (from a specific date until a specific date) and the granularity of aggregation (day, week, month) can be selected.

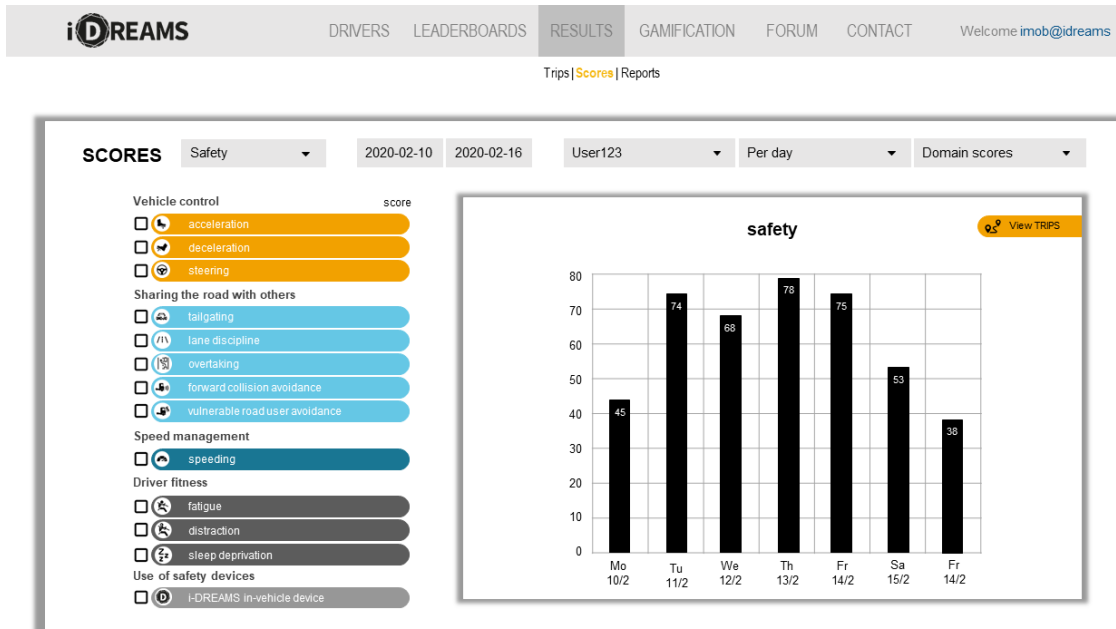

Figure 28: i-DREAMS web platform: results – scores (extracted from Vanrompay et al 2020).

2.4.5.5 Gamification: coping tips – pros and cons

Coping tips and advantages and disadvantages related to specific performance objectives can be listed, created, edited, and removed in the screens shown in Figure 29 and Figure 30.

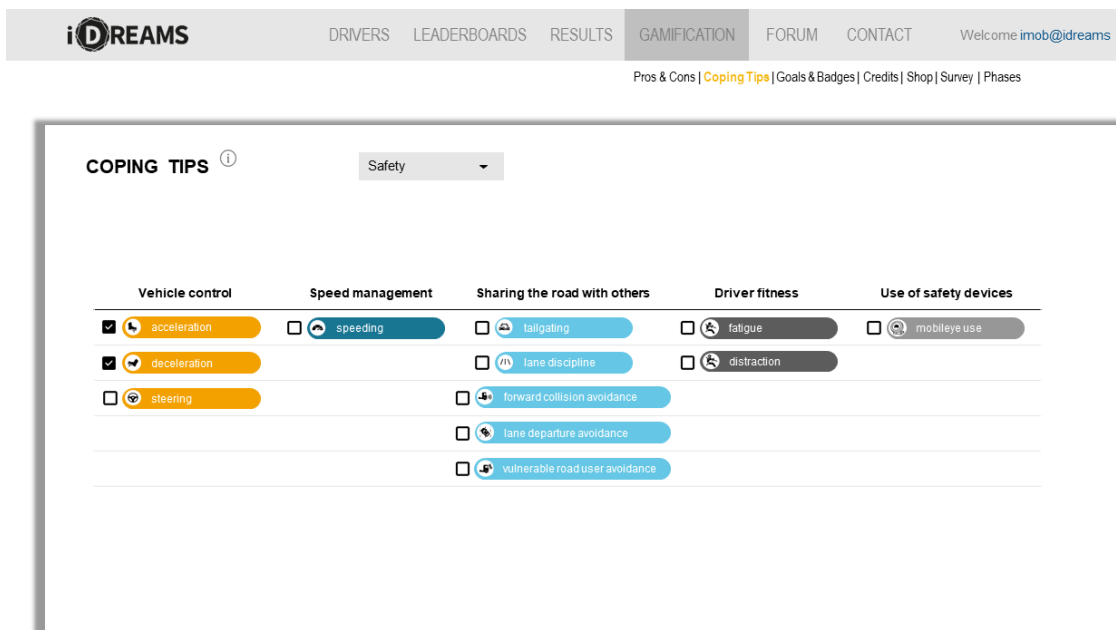

Figure 29: i-DREAMS web platform: gamification - coping tips (extracted from Vanrompay et al 2020).

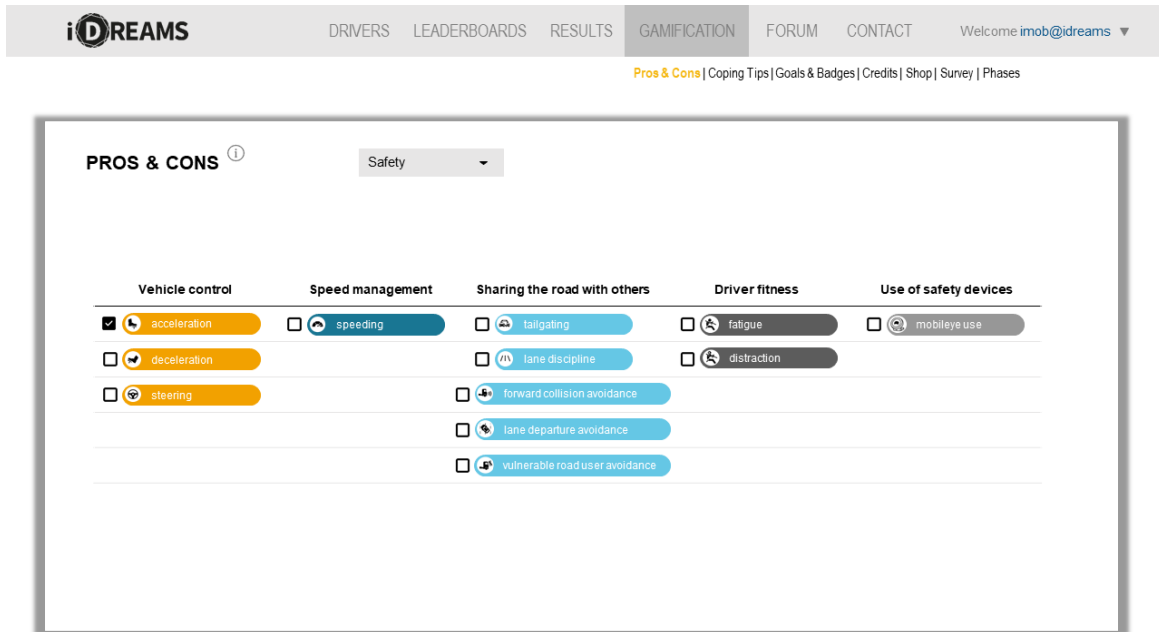

Figure 30: i-DREAMS web platform: gamification - pros and cons (extracted from Vanrompay et al 2020).

2.4.5.6 Gamification: goals and badges

Goals for each performance objective can be listed and edited in the goals screen (Figure 31 and Figure 32).

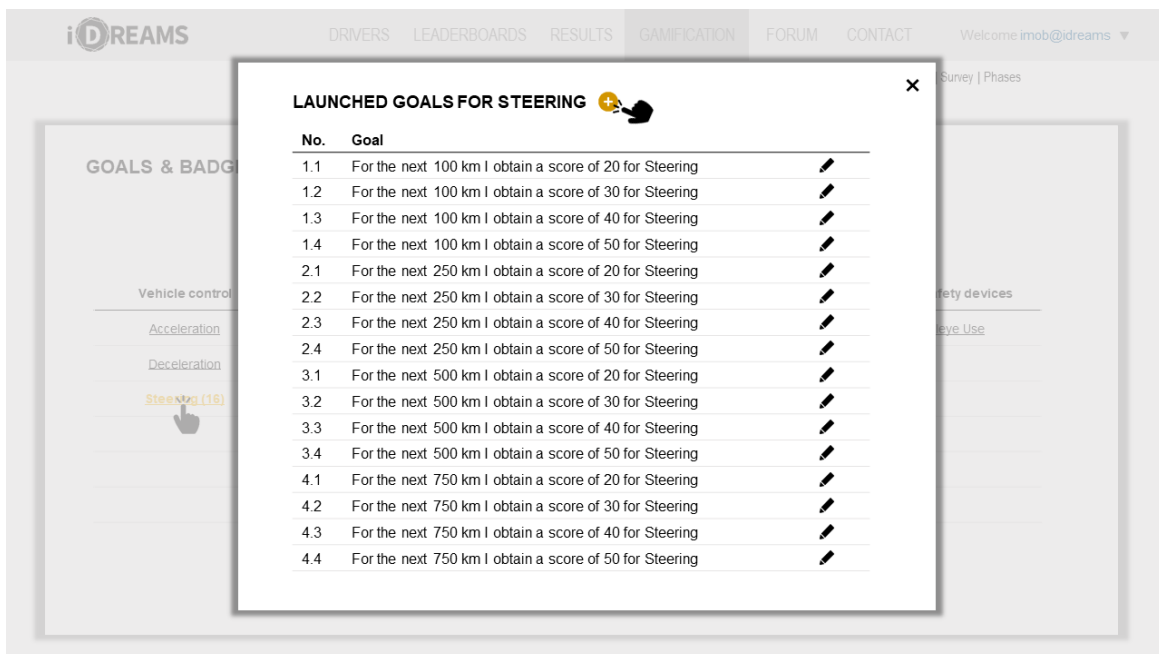

Figure 31: i-DREAMS web platform: gamification – goals (extracted from Vanrompay et al 2020).

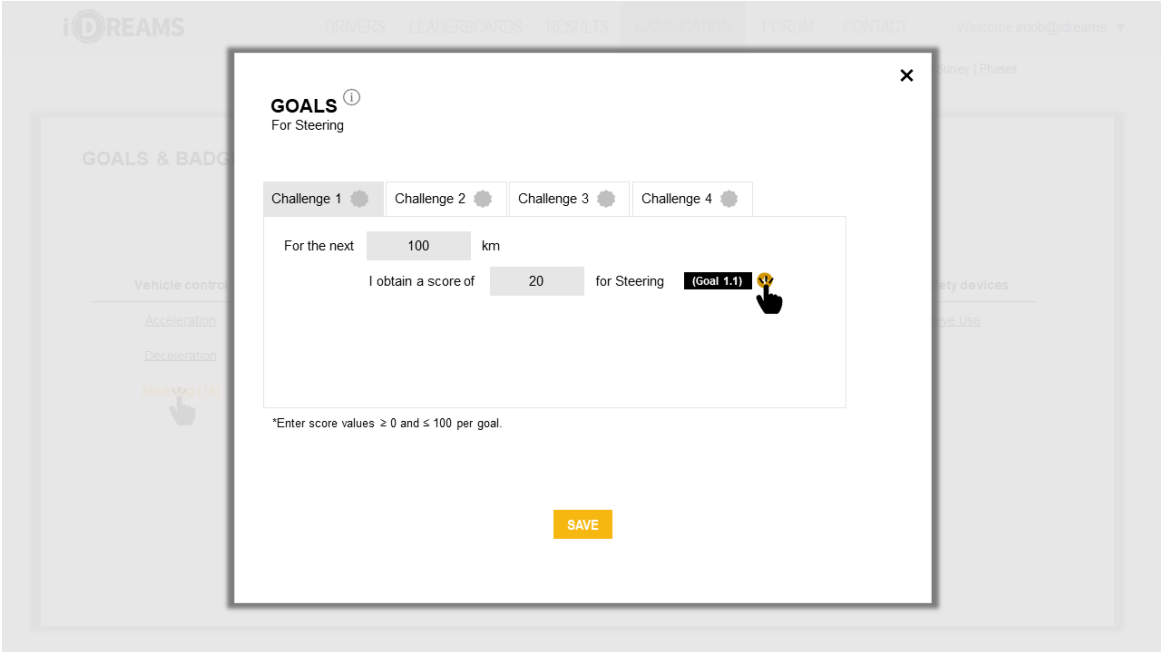

Figure 32: i-DREAMS web platform: gamification - new goals (extracted from Vanrompay et al 2020).

Badges can be obtained when a driver succeeds in a set of goals for a performance objective. Four different badges have been defined: bronze, silver, gold, and platinum, which can be obtained in increasing levels of difficulty (expressed by subsequent sets of goals). The badges obtained by a driver are shown in Figure 33.

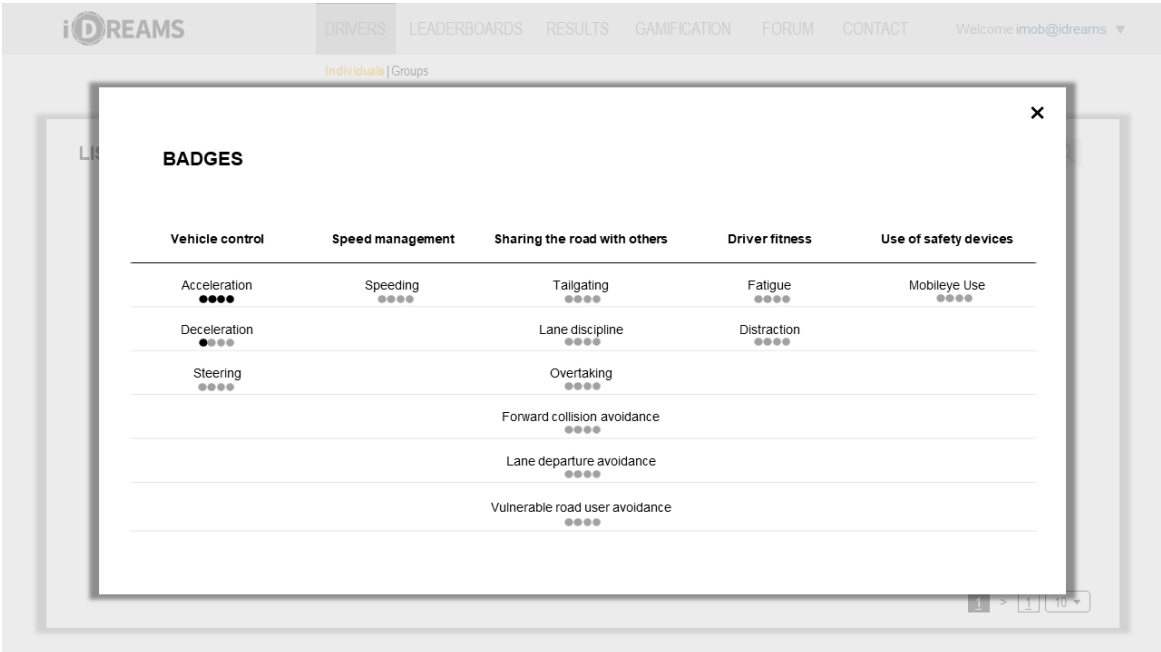

Figure 33: i-DREAMS web platform: badges (extracted from Vanrompay et al 2020).

2.4.5.7 Gamification: surveys

A driver can perform surveys in the i-DREAMS smartphone app, which increase their knowledge with respect to safety promoting goals and performance objectives. Survey

management and adding, editing, and removing questions is possible in the survey screen (Figure 34).

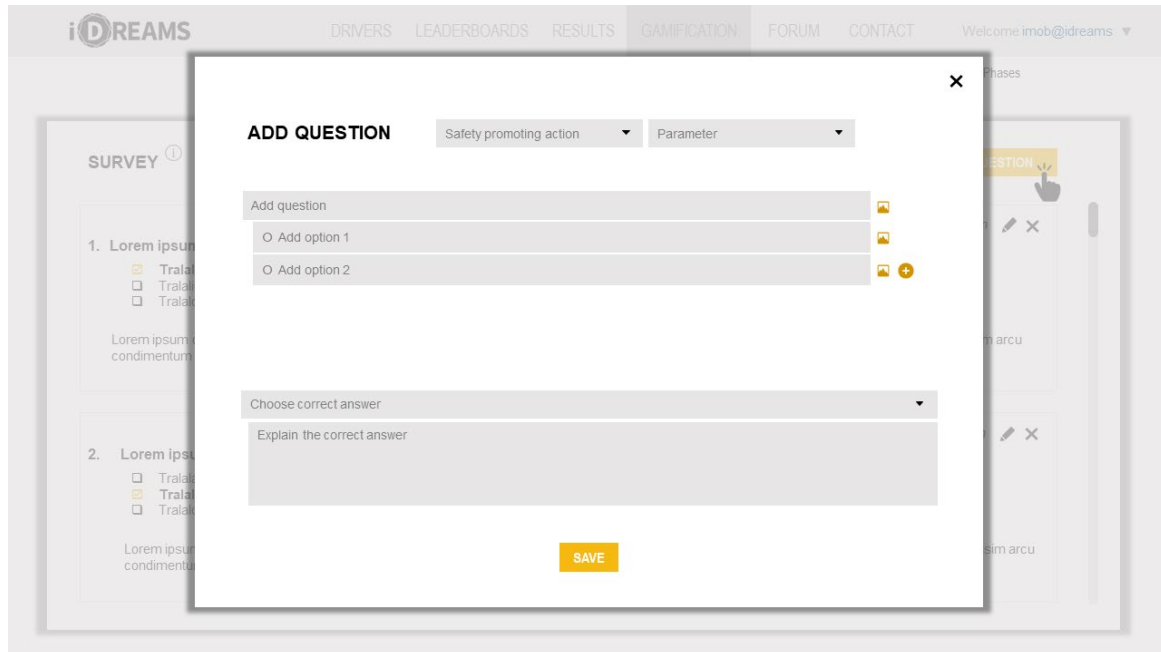

Figure 34: i-DREAMS web platform: gamification – survey (extracted from Vanrompay et al 2020).

2.4.5.8 Gamification: shop

The project leader can administer the items in the shop: adding, editing, and removing products (Figure 35).

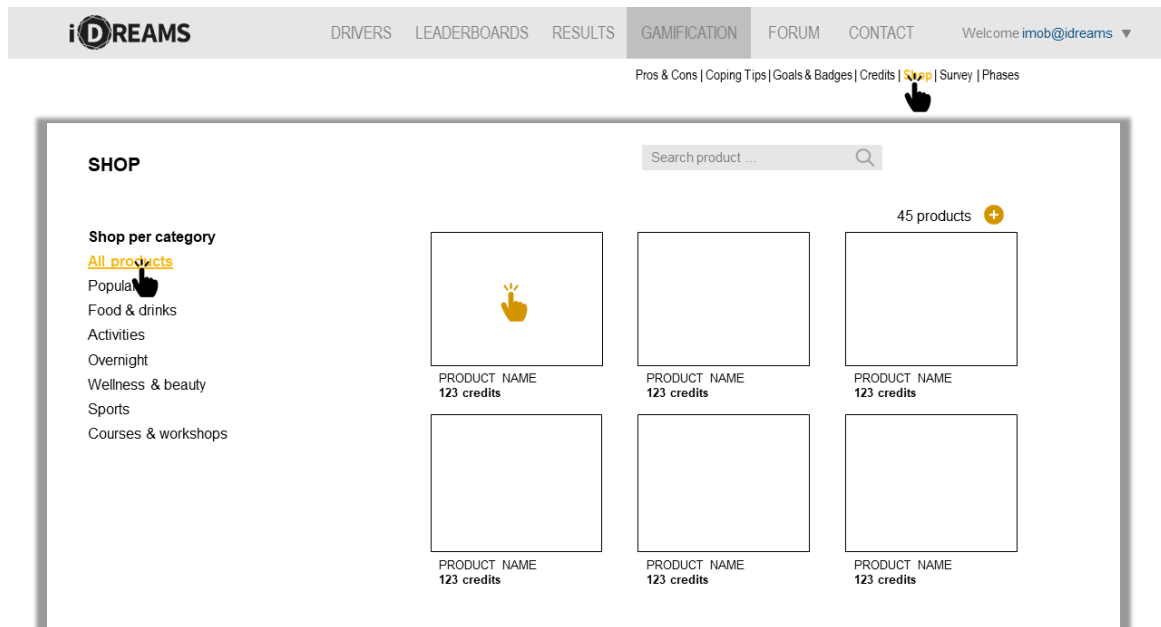

Figure 35: i-DREAMS web platform: gamification – shop (extracted from Vanrompay et al 2020).

2.4.5.9 Gamification: phases

Gamification features are available in the *i-DREAMS* smartphone app according to which psychological profile (behavioural phase) the driver is in. If needed, the functionalities available corresponding to the different psychological profiles can be changed in the screen shown in Figure 36.

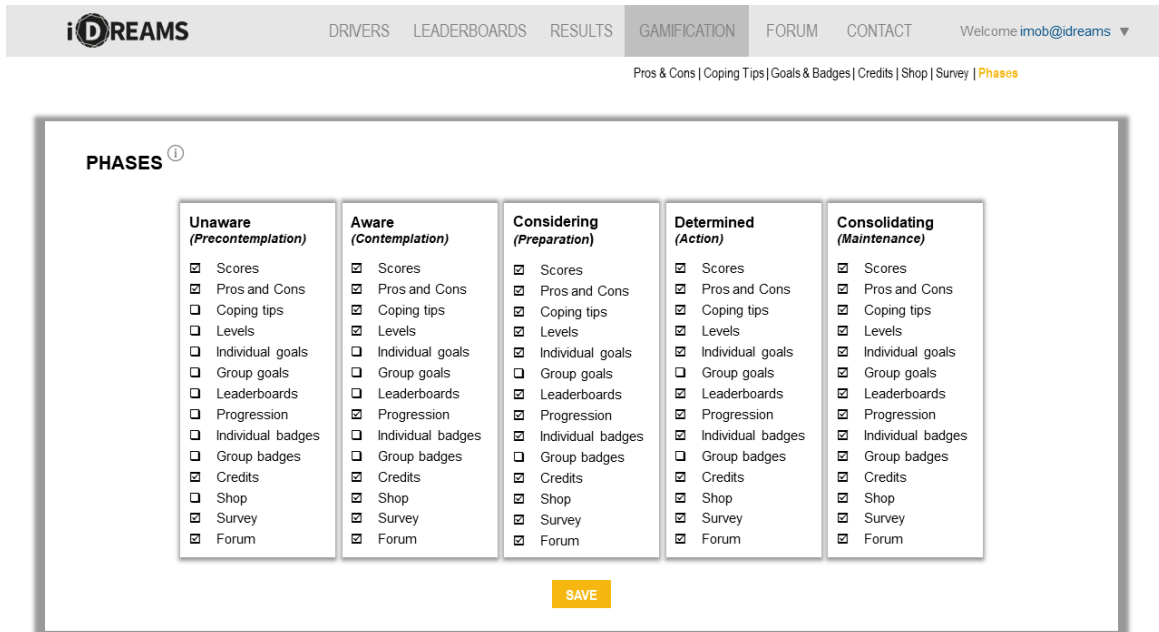

Figure 36: *i-DREAMS* web platform: gamification – phases (extracted from Vanrompay et al 2020).

2.4.5.10 Forum

The project leader can view and post messages to a specific driver, a group of drivers, or all drivers in the project. They can consult replies to messages and see how many views or likes a specific message got (Figure 37).

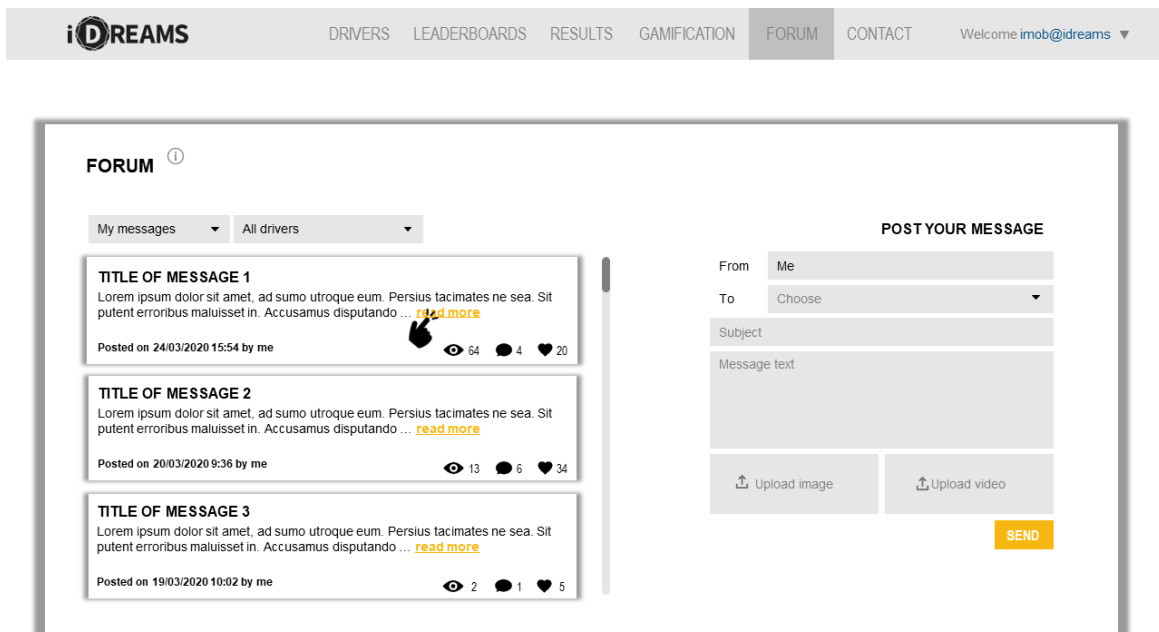

Figure 37: *i-DREAMS* web platform: forum (extracted from Vanrompay et al 2020).

3 Methodologies

The tools described in the previous section form the basis of how the *i*-DREAMS platform monitors, handles, and presents relevant trip data to the driver, in a way that is as efficient and clear as possible. This section, on the other hand, describes the methodologies adopted for the actual computation of the Safety Tolerance Zone phase, in addition to describing how the field-trials were carried out and the methods employed for the analysis of all collected data.

3.1 Detection of coping capacity and task complexity

The monitoring element of the *i*-DREAMS platform (Figure 38, reproduced from earlier) aimed to collect enough data to identify which phase of the STZ the driver was in, so that interventions could be delivered if the driver moved to a riskier phase. Thresholds were selected to define the STZ per performance objective (Figure 39, reproduced from earlier).

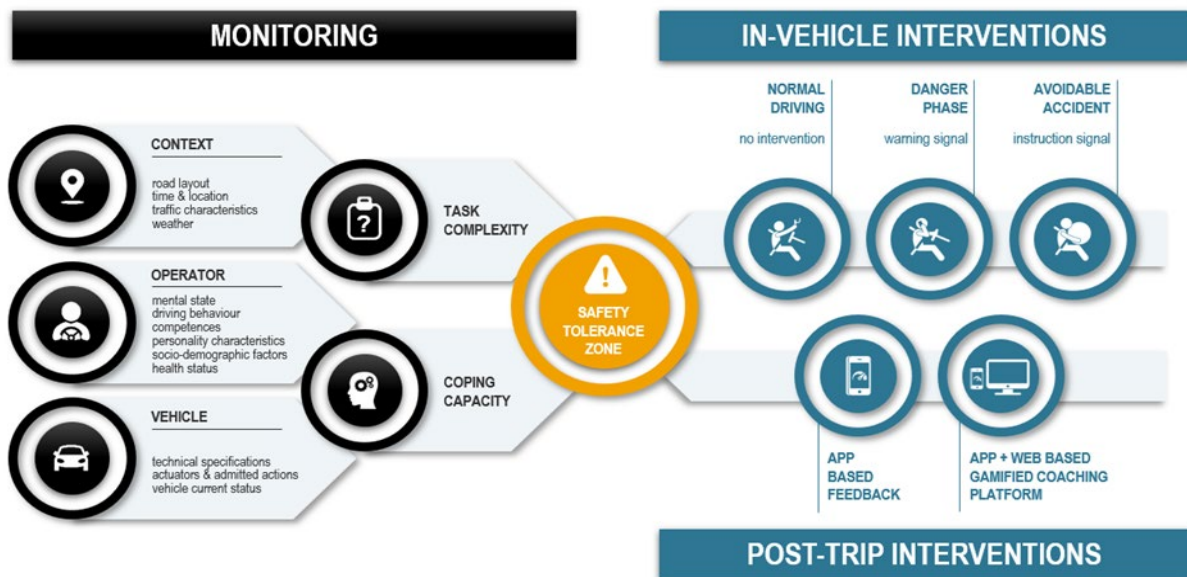

Figure 38: Conceptual framework of the *i*-DREAMS platform.

Performance objectives either describe an impaired state or driver behaviour, as these are the aspects that the drivers have some control over and therefore can be influenced by the *i*-DREAMS interventions. Performance objectives are directly related to the construct of *coping capacity*. However, the algorithms used to trigger interventions also consider other elements, such as age and gender, or aspects associated with *task complexity*, such as weather (rain measured by activation of the windscreen wipers) and trip duration. These modifying factors mean that the timing of real-time interventions can be influenced by measures of both *coping capacity* and *task complexity*.

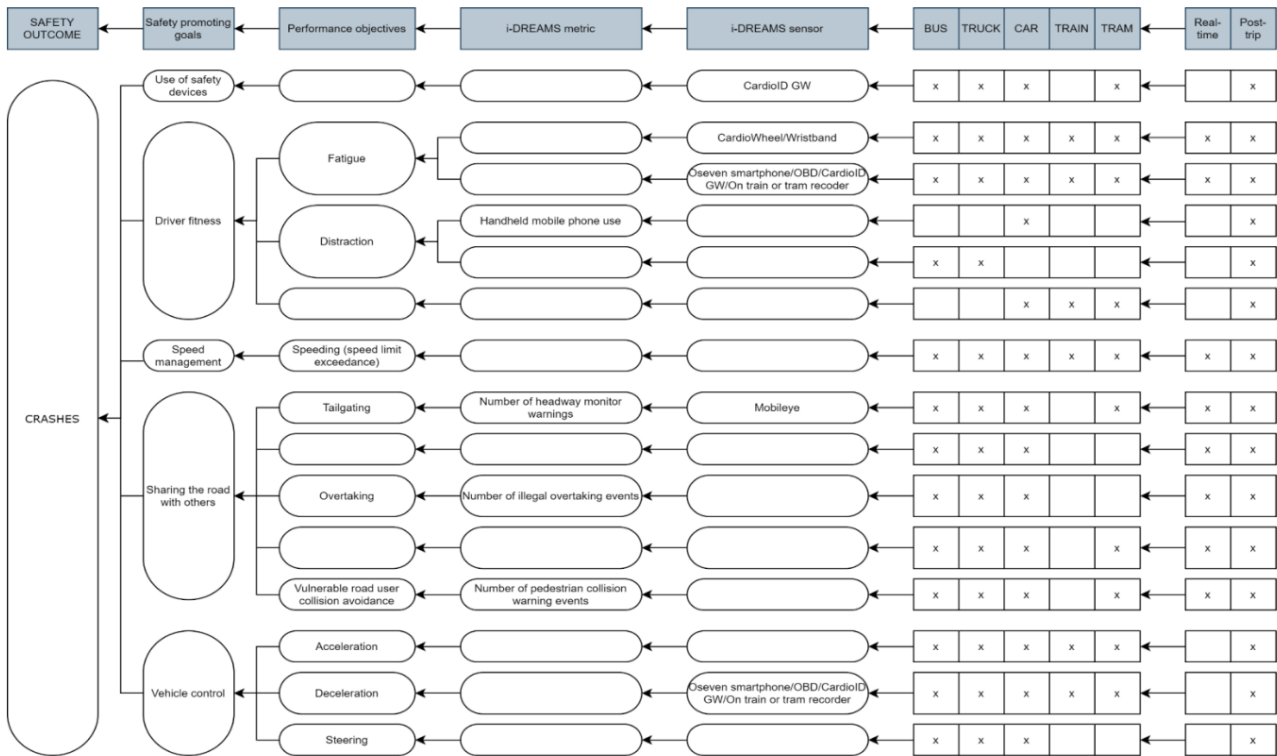

Figure 39: Safety promoting goals and related parameters.

Although the STZ concept can be applied to all modes addressed in *i-DREAMS* (car, bus, truck, rail), the different designs and constraints mean that the variables collected are not the same for all vehicle types. Table 7 shows the data collected to calculate the STZ per mode and the technology that collects them.

Table 7: Data variables collected per mode (extract from Talbot et al. 2021 – D3.1).

Implemented in i-DREAMS platform for STZ calculation				
Source	Description	Availability per mode		
		Cars	Trucks/Buses	Trams
Mobileye (AWS)	Headway time	*	*	*
	Vehicle ahead detected	*	*	*
	Pedestrian collision warning (PCW)	*	*	*
	Urban forward collision warning (UFCW)	*	*	*
	Forward collision warning (FCW)	*	*	*
	Left lane departure warning	*	*	
	Right lane departure warning	*	*	
	Low visibility indicator	*	*	*
	Time of day indicator	*	*	*
Mobileye (Cars)	Speed limit sign recognition	*	*	
	Wipers indicator	*	*	*
	Braking indicator	*	*	*

	Speed	*	*	*
	Left turn signal indicator	*	*	
	Right turn signal indicator	*	*	
GPS	Location (latitude and longitude)	*	*	*
	Speed	*	*	*
	Heading	*	*	*
CardioWheel	Sleepiness (from ECG signal)		*	
	Driver change detection (from ECG signal)		*	
	Hands on wheel detection		*	
	Steering wheel dynamics		*	
Wristband	Sleepiness (from PPG signal)	*		*
OSeven app	handheld mobile phone use	*	*	
Gateway	Harsh acceleration / braking / cornering (via IMU)	*	*	*
	Trip duration timer	*	*	*
Questionnaire	Age, gender, driving experience	*	*	*

In practical terms, four real-time in-vehicle interventions were designed to address the *i*-DREAMS performance objectives regarding headway, illegal overtaking, speeding, and driver fatigue. These warning strategies define specific thresholds representing each of the three STZ phases (see Table 8). Note that these thresholds are dynamically adapted by the specific driving situation, being affected by factors such as age, gender, driving experience, weather (rain), and the state of the other warnings.

The associations between coping capacity, task complexity, and their combination on risk (STZ levels) observed within *i*-DREAMS have been explored in the data analysis activities, being further explored here in Section 3.3.

Table 8: Connection between the three STZ phases and the thresholds for the 4 warning strategies.

	Real-time headway warning strategy	Real-time illegal overtaking warning strategy	Real-time speeding warning strategy	Real-time fatigue warning strategy
NORMAL DRIVING PHASE	THW > variable threshold (1.0s – 2.2s)	acceleration $\leq 0.2\text{m/s}^2$ OR speed < 35km/h OR turn signal and LDW indicator = 0	driving speed < variable threshold 1 (3.25% - 10% above speed limit)	DD* < 2 hrs AND KSS = low
DANGER PHASE	THW < variable threshold 1 (1.0s – 2.2s) AND THW > variable threshold 2 (1.2s – 0.6s)	acceleration $\geq 0.2\text{ m/s}^2$ and other indicators (KSS, etc.) are in normal ranges	driving speed between variable threshold 1 (3.25% - 10% above speed limit) and variable threshold 2 (4.75% - 15% above speed limit)	DD < 2 hrs AND KSS = medium; DD = medium AND KSS = low;
AVOIDABLE ACCIDENT PHASE	THW < variable threshold 2 (1.2s – 0.6s)	Acceleration > 0.2 m/s^2 and other indicators (KSS, etc.) are in abnormal ranges	driving speed > variable threshold 2 (4.75% - 15% above speed limit)	DD < 2 hrs AND KSS = medium or low; DD = medium AND KSS = medium; DD = medium AND KSS = high; DD = long AND KSS = low; DD = long AND KSS = med/high; DD = very long
<small>*DD = Driving duration, THW = Time Headway, LDW = Lane Departure Warning, KSS = Karolinska Sleepiness Scale</small>				

3.2 Real-World Trials

The *i*-DREAMS project featured a complex field operational trials (FOTs) across four modes of transport (passenger car, truck, bus, and rail) and five countries. FOTs were preceded by simulator trials to test the *i*-DREAMS platform ensuring the Safety Tolerance Zone (STZ) monitoring technology and models work appropriately. In deliverable D5.1, best practices when planning and implementing FOTs were identified, detailing the steps required by *i*-DREAMS for alignment with them, and the planned roadmap for the successful implementation of the FOTs and simulator trials. Additionally, in Pilkington-Cheney (2020) - deliverable D3.4, the design recommendations and specifications were presented, guiding the implementation described in Hancox et al (2020) - deliverable D5.3: Description of the on-road driving trials for identifying safety tolerance zones and the performance of in-vehicle interventions.

The trials started with a first stage - pilot testing - with a limited number of vehicles for each trial location. The purpose of the pilot tests was to fine-tune the *i*-DREAMS technology. This includes all the processes associated with production, installation, and interventions, but also collection, processing, and visualization of data. In addition, it offers the chance to implement changes based on user feedback before transitioning to large-scale testing.

After the pilot stage, the on-road trials focused on monitoring driving behaviour and the impact of real-time interventions (i.e., in-vehicle warnings) and post-trip interventions (i.e., post-trip-feedback & gamification) on driving behaviour. The experimental design of the *i*-DREAMS on-road study is displayed in Figure 40 and consisted of four stages:

- Phase 1 - Baseline measurement
- Phase 2 - Intervention Stage 1: real-time intervention
- Phase 3 - Intervention Stage 2: real-time intervention + post-trip feedback
- Phase 4 - Intervention Stage 3: real-time intervention and post-trip feedback + gamification

The purpose of the field trials was to collect the necessary data, which would lead to the identification of the STZ and the correlated conditions, to predict and explain the prevailing level of road safety and driving behaviour. The results are analysed in work packages WP6 and WP7, specifically in the deliverables 6.1, 6.2, 6.3, and 7.2.

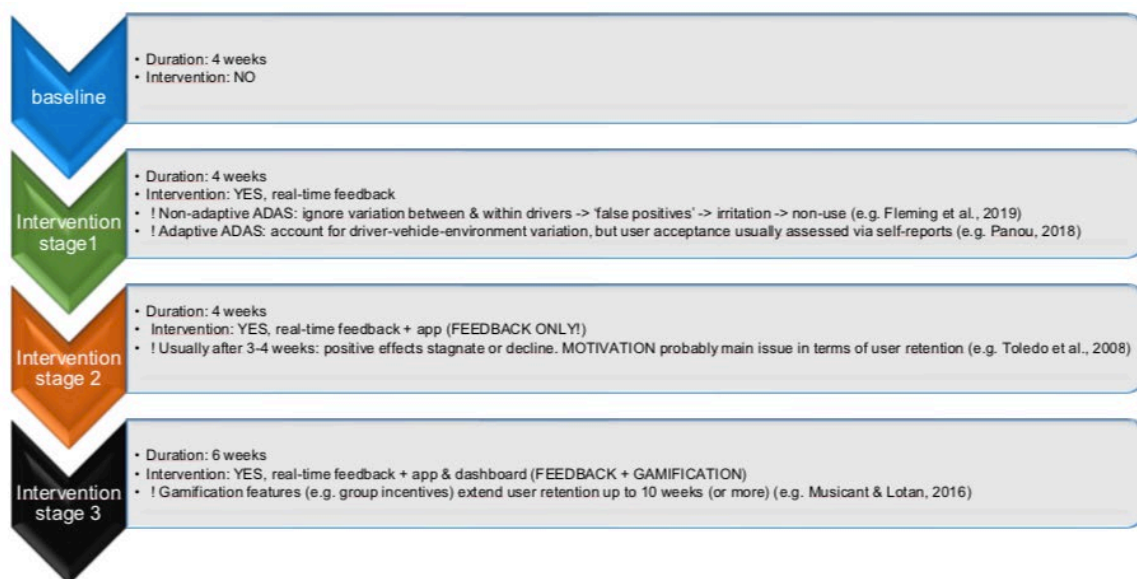

Figure 40: Overview of experimental design of the *i*-DREAMS on-road study.

3.3 Data Analysis

The interrelationship between task complexity and coping capacity and their effect on risk has been the focus of WP6 analyses, while the effect that the interventions had on changing driving behavior was the focus of WP7. The main results of the analyses are described in the following sub-sections.

3.3.1 Task Complexity, Coping Capacity, and Risk

To understand this relationship, analyses were split into predictive models, which aimed at analyzing the real-time effects of task complexity and coping capacity factors on the STZ level, and explanatory models that aimed at explaining the relationship based on post-trip data. The different approaches followed are depicted in Figure 41.

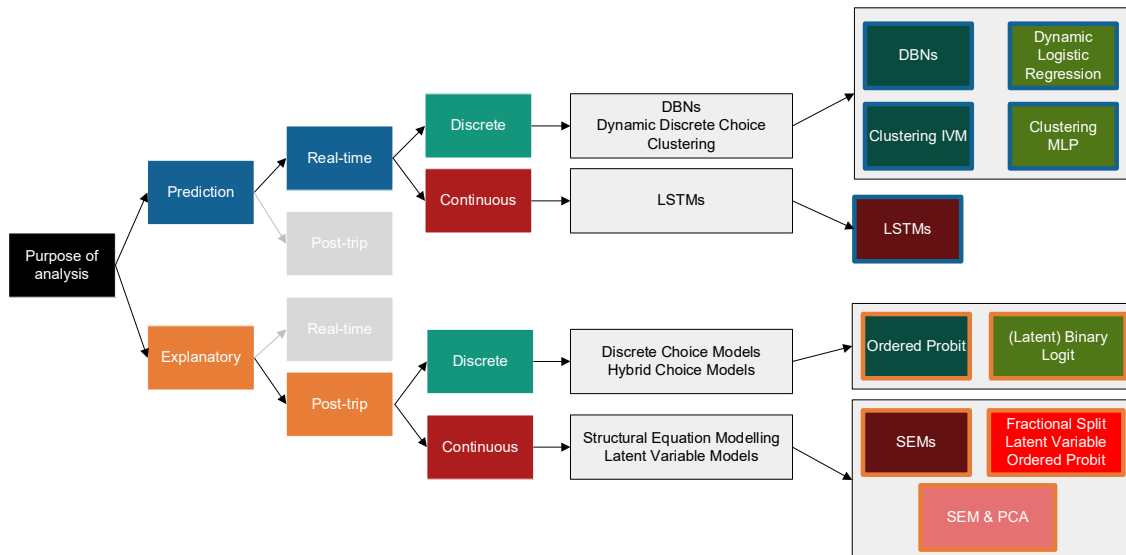

Figure 41: Schematic overview of modelling approaches for the analysis of risk factors.

The most noteworthy results are summarized below for the synthesis of risk factors:

- Results indicated that demographic characteristics, such as gender and age, had a negative correlation, indicating that male drivers and especially elderly people had a lower level of coping capacity.
- It was revealed that vehicle strain (increased vehicle age), along with type of fuel and trip difficulty, were associated with higher task complexity levels.
- Task Complexity and Coping Capacity are inter-related with a positive correlation. This positive correlation indicates that higher task complexity is associated with higher coping capacity, implying that drivers' coping capacity increases as the complexity of driving task increases.
- Task Complexity increase is associated with lower risk, which is not intuitive. Although the initial assumption was that Task Complexity would increase risk, once its effect is moderated by that of Coping Capacity, the opposite is the case. It is noted, however, that the Task Complexity latent variable is measured by environmental indicators (i.e., rainy weather, night-time), which are known to induce compensatory behaviours by drivers.
- Male drivers, as well as drivers with sportive driving style, driving faster than the speed limit over the last year, and higher perceived competence compared to the average driver are more likely to exhibit higher levels of the STZ. All these variables reflect the confidence and more aggressive behaviours that are known to be associated with violations.
- Drivers who think driving is very dangerous, and those who are familiar with the benefits of safe driving, have lower propensity of exceeding the normal STZ of speeding.
- Night-time driving and driving on rural roads also lead to higher propensity of speeding, possibly due to lower traffic during these hours.

- The structural relationship between Task Complexity and Coping Capacity remains positive across all trial phases, although it reduces in magnitude in Phase 4. Similarly, the relationship between Task Complexity and risk remains the same, although the magnitude increases in the negative direction. Moreover, the relationship between Coping Capacity and risk is also consistent across phases.
- The effect of trip duration was negative during Phase 1 of the experiment, but it changes to positive in the following phases of the experiment. This could be that, with the presence of interventions, the coping capacity of the drivers increases, and they can maintain normal driving for longer trips.

An example of a SEM model for the synthesis of risk factors is given in Figure 42.

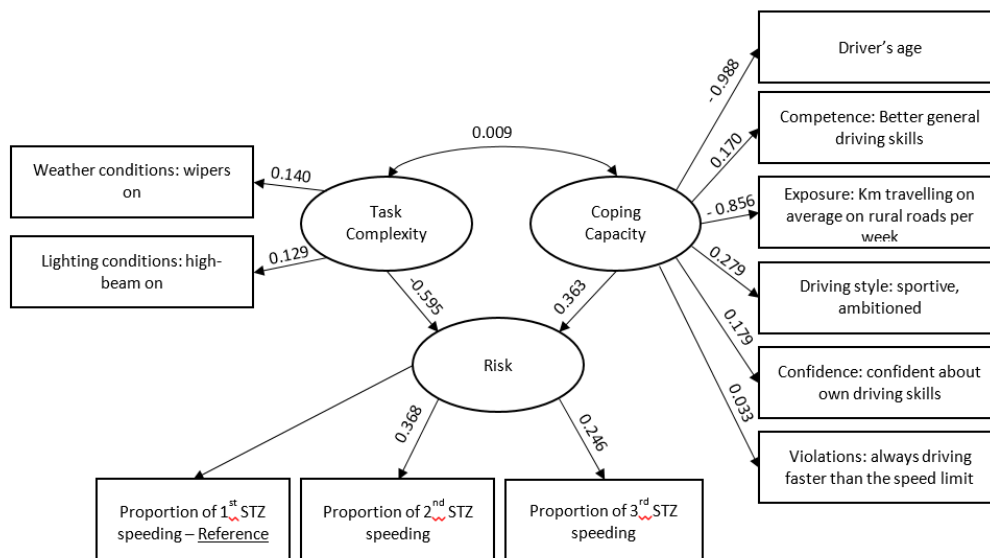

Figure 42: Example of SEM model for the synthesis of risk factors.

3.3.2 Analysis of Effect of Interventions

To evaluate the effectiveness of the *i*-DREAMS interventions in improving drivers' safety behaviours, analyses in two main areas were carried out: outcome evaluation and process evaluation. Outcome evaluation, also known as effect evaluation, measures the effectiveness of the intervention, i.e., it assesses whether the targeted factors of the on-road trials changed because of the intervention or not. Process evaluation, on the other hand, assesses which parts of the intervention were effective and which parts were ineffective. These analyses were performed for both in-vehicle real-time warnings and post-trip feedback. The following subsections summarize the main results reported in deliverable D7.2 (Effectiveness evaluation of the interventions).

3.3.2.1 Outcome Evaluation

Effects vary between countries, and between drivers. Regarding total events:

- Germany and UK drivers show a reduction in total events from Phase 1 to Phase 2, and from Phase 2 to Phase 3, before increasing again in Phase 4.

- Belgium drivers show an increase in events from Phase 1 to Phase 2, and from Phase 2 to Phase 3, then a reduction in events from Phase 3 to Phase 4.
- Overall effects are small, and a large standard deviation reflects a large variance between drivers, suggesting that effects are obscured when all drivers are considered together.
- Regarding total events for Belgium truck drivers, overall effects are small, with total events per 100 km increasing from 90.8 in Phase 1 to 92.0 in Phase 2, remaining steady at 92.1 in Phase 3, then decreasing to 90.2 in Phase 4.
- When individual drivers are considered, approximately 40% of them showed improvement.

3.3.2.2 Process Evaluation

- The use of the *i*-DREAMS app also varied between countries. For example, the total app visits were 2768 in Belgium, 342 in Germany, and 3594 in the UK.
- UK drivers had the highest app use, though showed significantly more app use in Phase 4 compared to Phase 3.
- For all countries the 'trip' and 'scores' functions were popular. For Belgium and Germany, the 'goal' menu was also popular, whereas for the UK the 'leader board' was highly visited.

4 Exploitation Plans

A fundamental pillar of the *i*-DREAMS project, given its goal of improving driving safety, is the definition and preparation of plans to exploit and foster the adoption of the tools and methodologies developed and validated throughout the project. This includes the commercial exploration of project results, conceiving a set of products and services that address the needs of specific markets. To this end, the consortium partners have agreed on a legal framework for the commercial exploitation of the *i*-DREAMS platform, by which the “Industrial Partners” (OSeven, CardioID, and DSS) shall take efforts to commercialize the results of the project. Furthermore, the actual definition of the exploitation plans was the focus of a dedicated task within Work Package 8 (Road map to market and society), from which resulted Deliverable D8.2 (Exploitation plans). A Business Model Canvas approach was used to determine the set of *i*-DREAMS products, services, and tiers that would best fit the target market segments, with a strong focus on the designed modularity of the *i*-DREAMS platform. Additionally, the transferability of the *i*-DREAMS system to other transport modes was also analysed, namely the rail, aviation, and maritime modes, based on a literature review and interviews with key stakeholders.

4.1 Modular Exploitation

The modularity of the *i*-DREAMS technology allows the creation of multiple versions of the system, with the potential to best adapt the available product features to the target market segments. To better understand the possible market impact of the envisioned *i*-DREAMS products, a market analysis was conducted, leading to the vehicle typologies described in Table 9, and expanded in D8.2.

Table 9: Vehicles registered in selected countries in January 2022 (Source: ACEA European Automobile Manufacturers' Association, Jan 2022)

Typology	Portugal	Belgium	Others	Notes
Company Cars	1 590 000	1 748 159	37 928 953	Considered 30% of Total Passengers Cars
Delivery VANS	1 140 000	829 416	14 718 755	Considered the total shown in the report
Heavy Vehicles	134 000	147 016	2 549 469	Considered the total shown in the report
Driving School Vehicles	5 000	5 000	25 000	
Coach Buses	17 000	16 451	269 150	Considered the total shown in the report
Learner Driver's Vehicles	NA	70 000	NA	NA = Not Available

For each of these market segments, the set of in-vehicle equipment is described in Table 10, while the web and mobile platforms used is described in Table 11. In these tables, the first column represents the envisioned service tiers, each targeting a specific market segment. This

approach allows to maximize, on one side, the number of *i*-DREAMS features that are appropriate for a given segment, while minimizing, on the other side, the cost of deploying the *i*-DREAMS system. In Table 11, the DSS Dashboard and DSS Coaching App services are derived from the *i*-DREAMS Dashboard and Driver App, respectively, while the O7 Standard and O7 *i*DREAMS are different versions of the OSeven mobile SDK, with the Standard version including the already commercialized OSeven features, and the *i*DREAMS version including the adaptations made for the integration with the CardioGateway within *i*-DREAMS. The O7 API allows access to data obtained from the mobile device, as well as access to the integration with OpenStreetMap data (road type, speed limits). Finally, CardioCloud is where trip data from CardioGateway is stored and processed, including handling of videos from the Dashcam.

Table 10: Versions of the *i*-DREAMS in-vehicle equipment, customized for each market.

Set/Service	CardioGateway	Dashcam	Intervention Device	Mobileye	CardioWheel
SmartFleet Lite	X	X			
SmartFleet Basic	X	X			
SmartFleet Activation	X	X			
SmartFleet Premium	X	X		X	
Learner Driver App					
Driver Teacher Assistance					
TransportFleet Basic	X	X	X	X	
TransportFleet Advanced	X	X	X	X	X

Table 11: Versions of the *i*-DREAMS web and mobile services, customized for each market.

Set/Service	DSS Dashboard	DSS Coaching APP	O7 Standard	O7 <i>i</i> DREAMS	O7 API	CardioCloud
SmartFleet Lite	X		X		X	
SmartFleet Basic	X					
SmartFleet Activation	X	X		X	X	
SmartFleet Premium	X	X				
Learner Driver App		X				
Driver Teacher Assistance	X	X		X		
TransportFleet Basic		X				
TransportFleet Advanced	X	X			X	X

4.2 Expanding the *i*-DREAMS Ecosystem

To help the adoption of *i*-DREAMS technology in certain markets, additional third-party monitoring technologies were added to the set of equipment supported by the *i*-DREAMS system, as an alternative to the CardioGateway and other research equipment that was used during the field trials. The main factor for this decision were:

- To address technological and scalability concerns related to custom hardware, resulting from the global chip shortage (CardioGateway components were affected by this shortage leading to large lead times).
- Quality assurance and conformance with market specific directives for fleet monitoring hardware that can be guaranteed by the third-party supplier with already certified equipment.
- Opportunity to reduce the cost-per-installation by using third-party equipment, already being produced in large volumes.
- Easier adaptation for external installers already familiar with third-party equipment, or vehicles already equipped with third-party equipment.

After comparing the solutions offered by different suppliers of GPS trackers and fleet monitoring hardware, equipment from *Teltonika*³ was selected for integration into the *i*-DREAMS platform. The main reasons being the availability of hardware, the well-documented device features, and the options of device configuration. Furthermore, with the selected *Teltonika* devices, which includes GPS trackers, dashcams, and a smart camera similar to Mobileye, it is possible to capture a large part of the driving parameters that are a key part of the *i*-DREAMS technology. Still, some compromises had to be made. Like most third-party hardware, *Teltonika* GPS trackers do not allow for edge computing based on custom *i*-DREAMS software (one of the distinct features of the complete *i*-DREAMS system). Also, the processing power is significantly lower compared to the CardioGW. This means that a large part of the trip processing that was originally performed on-vehicle now needs to be done elsewhere. To address this, an architecture allowing external trip processing, based on datapoints acquired from the GPS tracker, was created.

4.2.1 Trip processing architecture for GPS trackers

A schematic overview of the architecture for trip processing with GPS trackers is presented in Figure 43. While driving, GPS trackers establish connection to a server for continuous, almost real-time sending of datapoints. The data sending protocol is not standardized and is usually defined by the manufacturer of the GPS tracker. To handle the reception of data from GPS trackers, *Flespi*⁴ was chosen as an in-between layer. After configuring the GPS tracker to establish connection to a *Flespi* server, *Flespi* handles the communication with the GPS tracker according to the specified data sending protocol. Crucially, *Flespi* also handles standardization and storage of datapoints, which can be retrieved through an API. This standardization layer, combined with a wide range of data sending protocols available, means that by using *Flespi* as an in-between layer, trackers from other manufacturers can easily be added and integrated into the *i*-DREAMS platform.

³ <https://teltonika-networks.com/>

⁴ <https://flespi.com/>

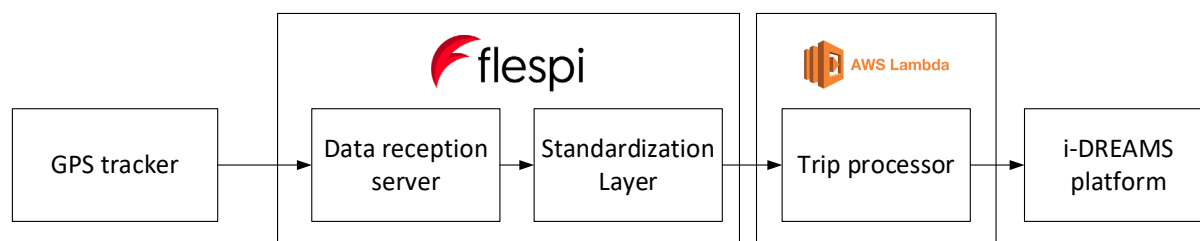

Figure 43: Trip processing architecture for GPS trackers.

The actual aggregation and processing of datapoints into a standardized *i-DREAMS* trip format is performed by the trip processor. To facilitate a low-maintenance, highly scalable solution, a serverless application was created, where trip processing is performed by AWS (Amazon Web Services) Lambda functions, before being sent to the main *i-DREAMS* backend.

4.2.2 Overview of integrated hardware

To help with adaptation of *i-DREAMS* technology in the fleet market, two complete solutions using *Teltonika* technology were created. An entry level solution, built around the *Teltonika FMC125* GPS tracker, and a second solution with more features, built around the *Teltonika FMC640* GPS tracker. Both solutions include collection of the GPS trace, driving speed (overspeeding), and vehicle control parameters (harsh acceleration, braking and cornering). Video clip recording of critical events is also available for both solutions. In addition, the FMC640 solution also features a smart camera that provides real-time interventions and allows for the collection of road sharing parameters (vehicle following, forward collision, lane discipline and VRU collision).

4.2.2.1 Teltonika FMC125 solution

FMC125 is a GPS tracker with a small footprint that allows for easy installation. It does not have the ability to interface directly with the vehicle through CAN-bus, but has other interfacing options, including the connection of a “DualCam” dashcam and a panic button. The DualCam dashcam records footage in a loop while driving. Short video clips can be requested from the camera for over-the-air transmission through the FMC125 GPS tracker. These clips can be viewed through the *i-DREAMS* web dashboard or driver app. The panic button can be used by the driver to manually indicate a critical event for which a video should automatically be pushed for visualization in the *i-DREAMS* platform. Driver identification with the FMC125 tracker is performed through the usage of BLE beacons, either as a small keychain beacon, or through the driver app installed on the drivers’ smartphone. An overview of the components in the FMC125-based solution is provided in Figure 44.

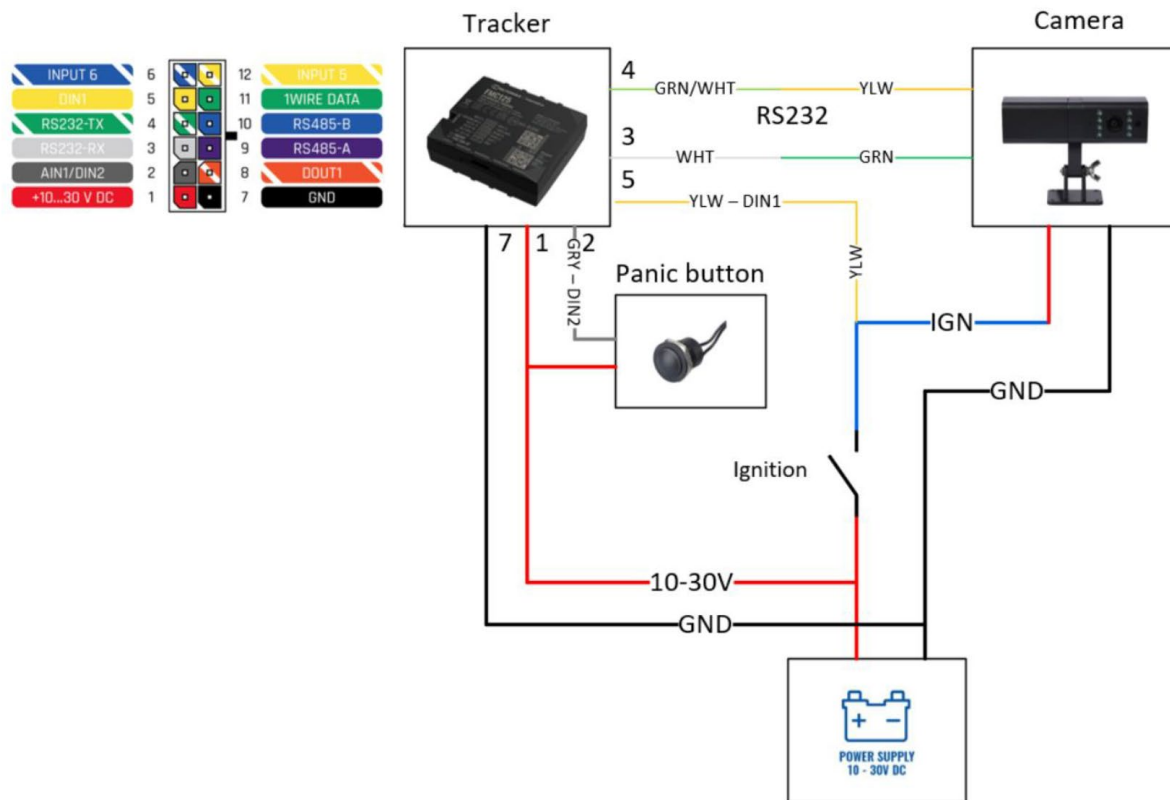

Figure 44: Connection scheme of the FMC125-based solution, taken from the installation manual.

4.2.2.2 Teltonika FMC640 solution

FMC640 is a feature-rich GPS tracker with external antennas for GPS and 4G and many interfacing capabilities. The two CAN-bus channels provide the ability to interface directly with the vehicle through FMS (Fleet management system), or other CAN-based protocols. Other interfacing capabilities include the option of connecting an “ADAS” smart camera and a panic button. The ADAS camera is able to collect parameters related to road sharing, including vehicle following, lane discipline and collision avoidance. Moreover, it also functions as a dashcam, recording footage in a loop while driving. Short video clips can be requested from the camera for over-the-air transmission through the FMC640 GPS tracker. These clips can be viewed through the *i-DREAMS* web dashboard or driver app. A small display, connected to the ADAS camera, provides real-time interventions to the driver. The panic button can be used by the driver to manually indicate a critical event for which a video should automatically be pushed for visualization in the *i-DREAMS* platform. Driver identification with the FMC640 tracker is performed through the usage of BLE beacons, either as a small keychain beacon, or through the driver app installed on the drivers’ smartphone. Additionally, the connection to FMS in trucks and buses allows for driver identification directly from the driver card. An overview of the components in the FMC640-based solution is provided in Figure 45.

Wiring Scheme: with FMS

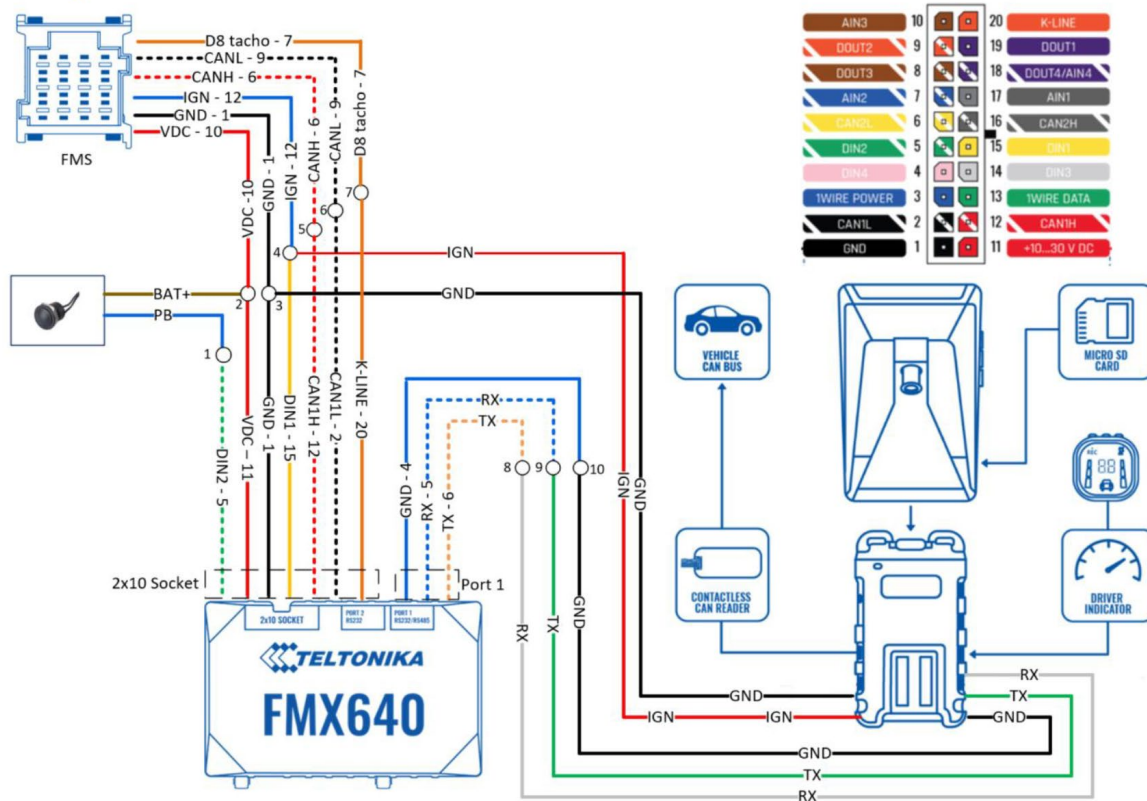

Figure 45: Connection scheme of the FMC640-based solution, taken from the installation manual.

4.3 Mode Transferability

Although the *i*-DREAMS system was primarily developed with road vehicles in mind, it was envisioned from the start of the project that the concepts, methodologies, and approaches conceived throughout *i*-DREAMS should also be expanded into other transport modes, specifically rail (i.e., heavy trains), aviation, and maritime modes. Although similar risk factors exist in all these modes, monitoring operators and applying interventions is more widespread in the road sector. In the rail sector, operator monitoring is implicitly accounted for by the strict timetables and regulations. In addition, the difficulty of installing in-cabin technologies has largely prevented the use of these technologies so far. In the maritime sector, as the relatively low speed and density of maritime traffic leaves quite large reaction time margins for the navigating officers, the emphasis is put on alerting the operator for risks in the environment rather than their own steering behaviour. In the aviation sector, operator monitoring is mostly carried out within standard training, re-training, and fitness screening processes by means of medical evaluations, neuropsychological tools, simulator sessions, etc. Meanwhile, automation and other advanced operator technologies are more common in the aviation sector than in other sectors. Overall, there is no systematic knowledge sharing about operator monitoring and intervention strategies that can provide insights for reducing risk factors that are common among all transport modes, especially human factors (Papadimitriou et al., 2020). To address this gap, this section aims to investigate the possibility of transferring knowledge between roads in *i*-DREAMS and other transport modes, i.e., rail, aviation and maritime. With this knowledge on hand, future implementation plans can be designed to address these other modes. Mode transferability is investigated by means of a literature review and expert interviews, considering three perspectives: (i) definition of risk and risk factors (the STZ concept in *i*-DREAMS), (ii) monitoring technologies, and (iii) intervention strategies.

First, the most important risk factors that are common among road, rail, aviation, and maritime were reviewed from the literature in these transport sectors. A thorough review of important risk factors and the state-of-the-art monitoring technologies and intervention strategies for the road sector was carried out in previous deliverables (see, for example, Kaiser et al. (2020), - D2.1 and Katrakazas, C. (2020) - D2.2). A similar (although less extensive) review for the other transport modes was carried out for the purpose of this deliverable. The details of this review (including the methodology and selection criteria) can be found in Afghari et al. (2022) and the results of the review are presented in Annex 2 of this deliverable. A summary of the review results is presented in the following:

- The definition of risk on the road is typically based on the number of crashes that occur, in terms of frequency or probability (e.g., rate of number of accidents per amount of traffic exposure). However, crash data are not always available or sufficient to proactively identify risk. Therefore, a family of other metrics and indicators is often used, namely surrogate measures of safety. These may include indicators such as headways, time-to-collision, harsh accelerations or braking etc., which in many cases correlate very well with actual crashes.
- In contrast, collisions are very rare for rail, where traffic (particularly in the case of trains) is largely controlled by the use of signals across the network. As a result, the definition of risk for this literature review was the train driver experiencing a SPAD (Signal Passed at Danger); this is when a train passes a stop signal when not permitted to do so, which is a potential precursor to an accident on the railway.
- In the maritime sector, risk is commonly defined based on the concept of the Time to Closest Point of Approach (TCPA) or Distance to Closest Point of Approach (DCPA), which are analogous to the time to collision approach (TTC) in the road sector. DCPA is defined as the closest distance of two encountered ships or one ship and one object passing by according to the current state of navigation.
- In the aviation sector, risk has been mostly defined in terms of the loss of control (e.g., due to pilot errors or technology failures) related to the ability of maintaining the dynamics of flight (e.g., airspeed and altitude deviations) and resulting in an 'undesired aircraft state or position'.

The comparison between risk factors across different transport sectors show that many risk factors are common among these sectors. Yet, there is no systematic way of dealing with these risk factors. This highlights the gap between the road sector and the other three transport sectors and identifies the potential benefits that could be gained from transferring knowledge between these sectors. Our review findings indicated that heart-rate measurements, eye tracking techniques, and speech recognition are researched for monitoring workload, drowsiness/fatigue, stress, and situational awareness in the aviation sector, however not implemented in practice. A complementary use of unobtrusive sensors seems necessary to enhance the reliability of monitoring. Proactive treatments such as taking a nap, caffeine intake, proper sleep environment, sufficient hours of uninterrupted sleep per night, consecutive nights recovery sleep are used for monitoring the operator's fatigue, sleepiness, and situational awareness in the maritime sector. Furthermore, in-cabin collision alert systems and blue light exposure are used as real-time interventions in this sector. While the road sector has been investigating systematic post-trip interventions (in the form of providing feedback about driving behaviour and giving scores to drivers in gamified platforms) to achieve a sustainable behavioural change over time, none of the rail, aviation, or maritime sectors make use of such post-trip interventions. Our literature review in the aviation sector, however, indicated that the

potential effectiveness of such post-trip treatment, when it is in the temporal proximity of the behaviour, has been recognized in this sector.

The above findings were then used to design semi-structured interviews with safety experts in rail, aviation, and maritime industries. These experts were chosen based on having extensive knowledge and experience of safety in the relevant transport industry. These included a representative from a regulator, a network operator safety manager, a training manager, and an academic working at a higher education organization.

A dedicated questionnaire was used for that purpose, properly adjusted for the different transport modes (see Annex 3). The interviews design received ethical clearance from the Loughborough University Ethics Committee, including the clearance for TU Delft researchers to perform the process. The interviews lasted between 50 and 70 minutes and were transcribed anonymously for further (qualitative) analysis. Questions were focused around the two issues of what *i*-DREAMS can learn to its benefit from other transport modes and whether the *i*-DREAMS system can be adapted to be beneficial for other transport modes. The analysis results on these interviews are presented per transport mode in the following sub-sections.

4.3.1 Rail Transport Mode

Rail interviews were carried out in the UK, between January and February 2022, with participants from all target groups (rail regulator, a network operator safety manager, a driver training manager and an academic). The diverse nature of the stakeholders interviewed was clear in their differing perspectives on the rail industry. As a result, there was limited crossover in the perceived issues, barriers, gaps and needs around the technology under discussion. However, participants agreed that alertness (normally related to distraction, inattention or sleepiness and fatigue) is a big risk factor in the rail industry, and balancing safety with performance is a constant tension.

The interviewees all raised the issue of the ad-hoc nature of safety systems currently present in train cabs in the UK. There are multiple safety systems in a train cab, and it was argued that these have not been cohesively designed as a single safety supporting tool. Alternatively, these have evolved over the years, been added and modified as and when necessary, sometimes in response to specific incidents. Consequently, they tend to be legacy systems which have been built into the train driver's working life layer by layer, presenting a range of in-cab warnings from different sources. It was therefore difficult for the interviewees to be definitive on which are the most significant/safety-critical systems. *i*-DREAMS would benefit from avoiding this situation.

Perspective (i): is the STZ concept relevant for rail?

The participants could perceive the potential advantages of the safety tolerance zone (STZ) in the rail context in that they recognized that the concept could be applicable. The similarity of the STZ to the existing signaling system was noted and the general opinion was that any safety system can be beneficial. However, they also identified barriers as follows: cost, cultural issues, infrastructure issues, technical feasibility, and union intervention. As noted above, the participants suggested that alertness and fatigue are a key concern in the rail industry and any related aspects of the STZ have the potential to be relevant.

Perspective (ii): can *i*-DREAMS technologies be used for rail?

The nature of heavy rail driving means that most of the *i*-DREAMS monitoring technologies cannot be directly applied to trains. If alternative monitoring technologies were utilized, then the *i*-DREAMS intervention technologies (real-time warnings and post-trip feedback) have potential in the rail context.

The potential benefits of post-trip feedback were recognized by all of the interviewees (more effective driving, learning from mistakes, an aid in the design of future systems) and it was suggested that gamification (comparison of scores between drivers) could have both positive and negative outcomes for drivers. The general consensus was that the success of introducing the idea would depend on how it was defined, who it was for and how people took that on board. It would be necessary to overcome some cultural and procedural matters to arrive at a point where drivers can perceive the usefulness of such feedback. It is worth noting that operators are already able to provide some post-trip information to drivers, however, this is perceived to be currently applied in a punitive way, that is, to investigate any mistakes or incidents. It was also claimed that there is current resistance to this idea, with drivers not wanting to be micro-managed or not seeing the point of this additional information.

Other *i*-DREAMS technologies were thought to be less useful in the rail context with concerns again expressed about adding another real-time warning system into the cab that was not integrated with existing systems.

Perspective (iii): is there any particular technology that we can adopt from rail?

No specific technologies seemed appropriate for the *i*-DREAMS system in their current form. This was due to the nature of current safety systems in trains in that they are mainly linked to signals along the track, and they have been developed as legacy systems. It may be possible to utilize some of the data collected for the train black box e.g., speed, signal status within an alternative monitoring system. Perhaps *i*-DREAMS could learn from the current situation and ensure that the system is more holistic and has involved train drivers and human factors and safety experts in the design.

4.3.2 Aviation Transport Mode

Aviation interviews were carried out in the period March-July 2022. All the participants were from the Netherlands, representing the roles of pilot, trainer, trainers' trainer, examiner's trainer, safety manager and accident investigator. All of them had more than one of the above roles within their airline, while one of them also had previous job experience in an aircraft manufacturer. It has not been possible to interview an academic expert on aviation safety, due to lack of availability of our contact persons in the relevant time period.

Overall, it was indicated that the safety management of the industry is heavily based on learning from the past to 'predict the future', which may not always be sufficient, and more focus needs to be placed on 'systems thinking', especially given the increasing complexity of the systems.

Risk factors that were outlined as currently relevant were fatigue, complacency (i.e., crews becoming less vigilant with automation), and distraction (e.g., pilots using their iPads while flight is on autopilot). Human factors are deemed very important in the interaction with automation. 'Automation mode confusion' has been observed and there is need to have more transparency on what the automation is doing. Interfaces are not always clear, and there is often alert-nuisance which leads to disuse of the systems. The question of human-in-the-loop and situational awareness – although the more correct term is 'spatial awareness' – remains relevant. It was also pointed out that there is operational pressure after the Covid-19 travel restrictions.

It was also noted that the industry is rather 'conservative' and a lot of safety features with good potential are tested first in small private airplanes for a long time, before they find their way to the commercial industry.

Perspective (i): is the STZ concept relevant for aviation?

There is a direct analogue to the STZ in aviation, namely the 'safe flight envelope', which is the design space for the aircraft, and there are monitoring systems (visual or audio alerts for low speed, overspeed, the angle of attack, the configuration of the aircraft, as well as weather, e.g. if you are approaching a thunderstorm). It is a 3-dimensional envelope, when compared to that of the road.

Another relevant concept is broader 'barrier' models of safety science, which are often used in aviation crash investigations (e.g., fault-trees), where barriers are placed at different stages of a process, and it can be identified at which level they failed: deviation barriers, recovery barriers, protection barriers etc. It is thereby noted that in aviation many deviations are recoverable if you have enough altitude and proper skills to react on time.

Perspective (ii): can i-DREAMS technologies be used for aviation?

There are many more real-time safety features and systems involved in an aircraft compared to the road, and there was a general consensus among the experts that nothing major is missing. In most alerts, there is a 'caution' level and a 'warning' level. The main difference from the road sector is that they can cause overload or confusion, while one cannot stop the aircraft and check. In some cases (e.g., Airbus) the automation system may take full control to recover if the human takes inappropriate actions (e.g., prevent deliberate actions). In some cases, however, the systems are not designed to alert the crew if there is a deviation but the systems detect that pilots are doing what they are supposed to. Therefore, some systems act as 'silent agents' and lead to sudden autopilot disengagements that may come as a surprise to the crew. In this respect, one of the experts mentioned that more 'intermediate' warnings would be useful – without however overloading the pilots.

From the pilots' perspective, human operator monitoring is achieved between the crew members, so in a way there is constant monitoring of each other. It is considered that the current safety systems make a very good job of avoiding collisions. There is quite a negative attitude among pilots to be digitally monitored, also due to personal data usage and privacy concerns.

In particular as regards fatigue, there is potential, but sensors like eye tracking, heart monitoring, or blood pressure might be needed. A technology like the *i*-DREAMS steering wheel cover would not be helpful because pilots hardly touch the steering wheel, but the wearables technology is an option several pilots might support. It was indicated that, on the one hand, it is important to be able to monitor one's own health status, because it is something that cannot be shared and interpreted together with other crew members. On the other hand, if the interpretation of this feedback was left to the pilot themselves, that might have its own risks.

It was confirmed, as was found in our literature review, that research on heart rate variability related to pilot stress or fatigue exists but is not yet in operations. From the accident investigators' perspective, there would be great potential in cockpit image recording (e.g., as is considered through dual cameras on the road), but that would find strong resistance from the pilots' unions because of potential accountability concerns and their legal implications.

One issue that was mentioned was the conflicting messages between certain systems that monitor the environment. For instance, communication with the ground, which is still carried out via VHF, can cause delays and loss of messages. Moreover, there can be different weather information coming from traffic controllers and from the in-cockpit flight radar. The need to integrate sensor data was outlined, because in several cases traffic controllers have decision authority, despite not being in the cockpit. Digital feedback from such integration of sensors

delivering feedback might be helpful. This could also be a useful direction for the future development of the *i*-DREAMS system on the road.

Post trip feedback does not exist in a standardised way in aviation. In many cases, there are monthly statistics that go to the airline, but different practices exist with what is done with these. Examples of individual statistics are, e.g., how many times there were too high speeds, or how many pilots did not reduce their speed enough during the last 10,000 feet, or were not fully prepared for landing with flaps setting and landing gear at certain altitude. In some cases, these kind of statistics are being fed back and they will also indicate certain general trends.

Formal personalised feedback about pilots' own performance might not be welcome by pilot unions, but there are certain issues that they might be interested in, e.g., how an individual handles fuel efficiency, which is an important topic for the industry. In a certain airline, if an incident happens then this might trigger a safety debate, and the crew is invited to discuss this with the safety management - not in order to blame them or punish them, but to learn from their experience. In principle, this remains anonymous for the company.

In other airlines, pilots are given feedback on their iPad enabling them to reconstruct their flight path or highlighting exceedances so that they can learn from that. But it is noted that it is extremely important to ensure data accuracy and integrity, to be able to implement this type of feedback more broadly.

Certain airlines are considering the creation of a dashboard system after every flight, but this has not as yet been developed or used. In addition, there is a lot of variability on how incidents are reported among airlines or in different investigations.

It has been mentioned that such personalized systems, however, might micromanage certain situations while losing the whole system perspective, so one of our experts would not be in favour of them. Also, our experts were not in favour of comparison with peers.

Perspective (iii): is there any particular technology that we can adopt from aviation?

There are several sophisticated systems in aviation that the road sector could learn from, especially while moving to higher levels of automation. Ground systems that show that one is in a collision course within 30 seconds have greatly improved the controlled flight into terrain type of accidents – in a similar way that FCWs have helped on the road. The Integrated monitoring system (ICAS) is a system that monitors all the technical systems and provides detailed information about all sensors, systems (hydraulic, electrical), and gives detailed input about the state and also interpretation of the warnings of lights that may pop up. The crew must still prioritize, but it solves the confusion over multiple warnings (since 1990), which is an issue that systems like *i*-DREAMS may encounter in their future development.

Furthermore, on autonomous navigation (autopilot), there are systems to alert the pilots if they have not touched anything in the cockpit, e.g., 30 minutes in flight, followed by an oral warning when there is still no pilot response. This can be interesting for the STZ real-time monitoring also within the context of keeping drivers alert in higher levels of automation.

There can also be problems arising from information overload. While in general a good practice, sensor redundancy and back-ups may also lead to confusion in determining which sensor gives the right information.

A potentially useful extension of *i*-DREAMS systems is that of tactile warnings, in addition to visual and auditory. Another system that is currently being developed in aviation is that of flight mode 'annunciators' which can show the pilots what exactly the automation is doing, but these need to be made more sophisticated.

Finally, a good practice from aviation is the regular retraining using simulators, with focus on safety critical situations and new technologies. These could also be helpful in retraining road drivers.

4.3.3 Maritime Transport Mode

Maritime interviews were carried out online, between March 2022 and January 2023, with participants from the Netherlands and Norway (in the academic sector), and in the UK (operators and safety managers). Unlike the rail interviews, interviewed stakeholders were not diverse, and thus they had very similar perspectives on the maritime industry. As a result, there was many common issues in the perceived issues, barriers, gaps and needs around the technology under discussion.

All of the participants agreed that the weather and the environmental factors are the major risk factors in this industry, whereas human factors are not a big issue in the maritime sector because there are fundamental differences between cars and ships, including vehicle dimensions, navigation speeds, and the crew on board. However, they did mention that fatigue (prolonged periods of time in the range of months in the deep sea) and lack of sufficient sleep is one of the important risk factors in the maritime sector. In addition, they all emphasized that the general safety culture and regulations in the maritime industry are very important factors, that could act as a barrier for adoption of technologies in this industry. It seems that there are still speculations about reducing the role of humans and replacing them by technologies.

Perspective (i): is the STZ concept relevant for maritime?

Although the interviewees agreed that a general definition of safe vs unsafe levels may be applicable to DCPA, they all emphasized that the differences between these levels may not be that much because in the sea, unlike in road traffic (where a bicycle may quickly cross the street and that the human operator has to respond to that), the speeds are much lower and the distances are much higher on the waterway. However, taking the analogy of the STZ levels in the maritime sector, the first STZ level would be equal to no traffic, sufficient water, good weather conditions, and a healthy and fit driver. As the traffic increases, the wind blows or in winter weather conditions, the second STZ appears. Finally, and as these conditions interact with one another, the third level of the STZ appears in which the ship is out of control.

Perspective (ii): can i-DREAMS technologies be used for maritime?

According to the interviews, electronic charts are the main technologies that are currently used on the ships, which show where other ships are in the neighbourhood. In addition, communication with the terminal or port authority is used to prevent collisions near the port and this is where technologies like *i*-DREAMS warning technologies can help. Additionally, because the ships may carry cargo, these technologies may help in identifying if temperatures are getting too high or if fluids are starting to move around a lot. While there are currently many ships that are navigating safely without any warning systems, *i*-DREAMS technologies could further improve safety if the shipping industry moves toward autonomous shipping. In this respect, a 3D representation of the route can optimize navigation behaviour and also avoid grounding.

The interviewees mentioned that the primary challenge in employing real-time interventions in the maritime sector is that there might be very limited opportunities to respond to those interventions. For example, in case of a fatigue warning, the ship cannot stop and rest. Therefore, the need for human replacement is always there. Another challenge in using interventions in the maritime sector is that the ship operators need to exchange knowledge and discuss the best manoeuvring strategy, which is not provided by the *i*-DREAMS

technologies. Overall, the interviewees agreed that there is a growing interest in adopting monitoring technologies in the ships, mostly because of the high costs of manpower. However, these (*i*-DREAMS) technologies are not yet there in the maritime, and so if they are to be adopted, they first need to be reviewed and investigated. In addition, there is a need for companies that want to turn the *i*-DREAMS concepts into products, and they need to meet their budgetary needs for ship owners to buy and install those products. In particular, the wearable technologies in *i*-DREAMS were emphatically mentioned by one of the interviewees. The potential of these technologies in detecting fatigue, and possibly correlating it with situational awareness, was deemed essential by the interviewee. However, trust in these technologies and whether they can detect the risky events correctly is another challenge in adopting these technologies.

Finally, according to the interviews, there are some discrete efforts in developing eco-friendly sailing apps which functions in a similar way to the gamification platform in *i*-DREAMS. This could be adopted for maritime safety as well. However, a big challenge in providing post-trip interventions for the maritime sector is the very long maritime journeys (in order of months) and so a post-trip feedback may not be practical or applicable.

Perspective (iii): is there any particular technology that we can adopt from maritime?

One of the technologies that the road sector and *i*-DREAMS can learn from the maritime sector is the radar systems on board of ships to monitor occurrences around the vessel. These radars can provide the crew and the operator with the trajectories of the ships and the conditions of the route. In addition, the electronic steering system in the vessels takes into account weather conditions and current conditions to steer the vessel. This analogy can be used in the road sector for accounting for traffic or weather conditions. Additionally, voice recorder systems inside the vessels (similar to the blackbox in aviation) record the voices of the crew for later use. Similar technology could be used for professional drivers in the road sector.

4.3.4 Summary

The literature review and the expert interviews in the rail, aviation, and maritime sectors showed that while there are commonalities between these transport modes, there are fundamental differences which may prevent full transferability of *i*-DREAMS methodology and technologies to other modes. However, certain aspects of the project are of high interest and may be used for other modes, conditional on further research. These aspects are real-time monitoring of fatigue and sleepiness, and post-trip feedback and gamification. Meanwhile, it is very important to note that such aspects need to be integrated sufficiently well with the general safety culture in each transport industry.

5 Policy Recommendations

Of great importance for the valorisation and exploitation of the *i*-DREAMS project is how legal, ethical, and societal aspects are to be handled. In this regard, a set of policy recommendations has been compiled in deliverable D8.3, targeting transport safety stakeholders across Europe. This advice is tailored to individual stakeholder's requirements, spheres of activity, and areas of influence. It covers all relevant areas, from EU level to national and local authorities, and targets also industrial stakeholders. Specifically, the recommendations highlight the added value of wide adoption of the *i*-DREAMS platform (and similar systems), as well as insights gained from running such a large naturalistic driving experiment.

The following stakeholders are the main intended targets of the compiled policy recommendations:

- European Commission
- European Road Transport Research Advisory Council
- Member States' federal and regional levels: Transport Ministries & Home Offices
- Public Transport Authorities & Operators
- Corporate fleets: truckage, coach, taxi or car sharing companies, as well as fleets of company cars
- Motor insurers and their associations
- Road safety organisations at European and international level
- Federation Internationale de l' Automobile (FIA) and national automobile/mobility clubs
- Original Equipment Manufacturers (OEMs)
- Suppliers of sensor technologies
- Providers of ICT infrastructure and tools in the realm of transport safety

A summary of the most relevant policy recommendations is listed below:

- For all stakeholders, it is recommended that, at all times, the necessary actions to safeguard privacy of the users of Information and Communications Technology systems (ICT), like the one devised by *i*-DREAMS, need to be taken.
- The European Commission is recommended to further explore the concept of a safety tolerance zone in forthcoming research calls, and to include the *i*-DREAMS principles in future amendments of legislation relevant for certificates of professional competence (CPC) of professional drivers. In addition, the take-up in – and scientific exchange between – all transport sectors is encouraged, including rail, maritime and aviation.
- Several areas for future search are addressed to the European Road Transport Research Advisory Council (ERTRAC), e.g., how assistive vehicle technologies can be made situationally adaptive and tailored to an individual's driving style, and how to increase people's willingness to make appropriate and sustained use of ADAS and higher levels of automation.
- Member States' Transport Ministries & Home Offices are encouraged to include in safety, as well as research & implementation programmes, support for the practical deployment of methods and tools as proposed by *i*-DREAMS, including in fleets of ministries and their contractors. In addition, *i*-DREAMS event data maps can help raising the efficiency of targeted police enforcement, validating the locations of existing

speed cameras and section controls, and identifying sections of crash-prone infrastructure for treatment.

- Public transport authorities & operators are recommended to employ *i*-DREAMS technology to support building a safety culture among their drivers - and to promote that also fleets of contractors be equipped with advanced safety features that seek to keep drivers in their safety tolerance zone. Attention should also be given to evaluate the developments of incidents, crashes, and energy consumption before and after implementation of such technology to substantiate its added value.
- Operators of car sharing fleets are recommended to consider ways how users can be made familiar with ADAS & *i*-DREAMS technology before they start their first trip with a specific make & model. Thereby it can be ensured that detrimental side-effects, such as by distraction, are largely avoided.
- The recommendations to motor insurers and their associations include the offering of individual risk-based premiums (pay as you drive, pay how you drive) and the take up of *i*-DREAMS technology in the development of such schemes.
- The Federation Internationale de l'Automobile (FIA), the automobile clubs' international umbrella organisation, is encouraged to include in future versions of the FIA Road Safety Index – a safety initiative targeted at industrial organisations – an option to award additional points in the so-called road safety footprint to those enterprises which apply *i*-DREAMS-related technology.
- Road safety organisations at European and international level are encouraged to share with their members & networks – including European and national policymakers – the added value of the *i*-DREAMS concept and to support further research and implementation in the field.
- Original Equipment Manufacturers (OEMs) are advised to exploit the abundance of data which has been recorded and made available by the *i*-DREAMS project. This would facilitate, amongst others, to gain deeper insight into microscopic adaptations of users to the in-vehicle warnings triggered by the *i*-DREAMS interventions, and to develop better understanding on how users behaviourally adapt to in-vehicle interventions during single trips, and over longer trip histories. Additionally, suppliers are advised to improve modularity, connectivity with peripherals, standardization of data exchange protocols, and the use of well-documented, high-level API's, in order to foster industry-wide adoption of effective ADAS systems.

6 Conclusions

The *i*-DREAMS project has developed and tested an extensive set of tools and methodologies that provide timely interventions to keep drivers & operators of different transport modes (car, bus, truck, and rail) in the so-called Safety Tolerance Zone.

Both the conceptualization and successful implementation of the field trials showcased that a widescale implementation of the project's results can substantially contribute to enhance driver behaviour, supporting the European Union's goal of reaching the 50% reduction target for road fatalities and serious injuries. Also, in other transport modes, such as in the rail, maritime, and aviation sectors, valuable contributions to safety improvements can be expected.

The exploitation of the project introduced different product variants, either because of the needs of each target group, or due to technological constraints. The modularity of the *i*-DREAMS design ensured that the development of these variants was possible and straightforward to do. The project includes a commercial exploration of results, conceiving a set of products and services that address the needs of specific markets.

References

- Kaiser et al. (2020), State of the art on endogenous factors for monitoring driver state and exogenous factors for task demand assessment and technologies for monitoring driver state and task demand. Deliverable 2.1 of the EC H2020 project i-DREAMS.
- Katrakazas, C. (2020) et al. Overview of state of the art technology for safety interventions (risk prevention and mitigation) and assessment of their effectiveness. Deliverable 2.2 of the EC H2020 project i-DREAMS.
- Brijs, K., Brijs, T., Ross, V., Donders, E., Yves Vanrompay, Y., Geert Wets, G., . . . Gaspar, C. (2020). Toolbox of recommended interventions to assist drivers in maintaining a safety tolerance zone. Deliverable 3.3 of the EC H2020 project i-DREAMS.
- Fuller, R (2000) The task-capability interface model of the driving process, *Recherche - Transports - Sécurité*, Volume 66, 47-57. [https://doi.org/10.1016/S0761-8980\(00\)90006-2](https://doi.org/10.1016/S0761-8980(00)90006-2).
- Fuller, R. (2005). Towards a general theory of driver behaviour. *Accident Analysis and Prevention*, 37, 461-472.
- Fuller, R. (2011) Driver Control Theory: From Task Difficulty Homeostasis to Risk Allostasis. In Porter, B. E. (Ed) *Handbook of Traffic Psychology*, 13-26, Academic Press: London.
- Katrakazas, C., Michelaraki, E., Yannis, G., Kaiser, S., Senitschnig, N., Ross, V., Taveira, R. (2020). Toolbox of recommended data collection tools and monitoring methods and a conceptual definition of the safety tolerance zone. Deliverable 3.2 of the EC H2020 project i-DREAMS.
- Talbot, R., Pilkington-Cheney, F., Hancox, G., Filtness, A., Brijs, K., Brijs, T., Ross, V., Katrakazas, C., Al Haddad, C., Taveria, R., Kaiser, S., Mateus, T. (2020) Framework for operational design of experimental work in i-DREAMS. Deliverable 3.1 of the EC H2020 project i-DREAMS.
- Pilkington-Cheney, F., et al., (2020). Experimental protocol. Deliverable 3.4 of the EC H2020 project i-DREAMS.
- Talbot, R. et al. (2021). Enhanced toolbox of recommended data collection tools, monitoring methods and interventions including thresholds for the safety tolerance zone. Deliverable 3.6 of the EC H2020 project i-DREAMS.
- Lourenço, A. et al (2021), A set of flexible modules for sensor data collection, integration and real-time processing. Deliverable 4.1 of the EC H2020 project i-DREAMS.
- Lourenço, A. et al (2020), A flexible driver-machine interface for real-time warning interventions, Deliverable 4.4 of the EC H2020 project i-DREAMS.
- Vanrompay, Y., Donders, E., Fortsakis, P., Brijs, T., Brijs K. & Wets, G. (2020). A smartphone app (Android) for personalized driving behavioural feedback. Deliverable 4.5 of the EC H2020 project i-DREAMS.
- Vanrompay, Y., Donders, E., Brijs, T., Brijs, K. & Wets, G. (2020). A web platform for personalized goal setting, tips & tricks, and social gamification. Deliverable 4.6 of the EC H2020 project i-DREAMS.
- Hancox, G. et al (2020), Simulator & Field Study Organisation & Support. Deliverable 5.1 of the EC H2020 project i-DREAMS.
- Papadimitriou E., Schneider C., Aguinaga Tello J., Damen W., Lomba Vrouwenraets M., ten Broeke A. (2020) Transport safety and human factors in the era of automation: What

can transport modes learn from each other? Accident Analysis & Prevention 114, 105656.

Afghari, A.P., Papadimitriou, E., Maynard, S., Talbot, R., Filtness, A., Wets, G. (2022). "Risk Factors, Monitoring Techniques, and Intervention Strategies: Experiences and Lessons from Different Transport Sectors". Road Safety and Simulation Conference, 08-10 June, Athens, Greece.

Annex 1: Expanding the *i*-DREAMS Ecosystem installation notes

A complete set of installation tools and procedures was developed for both solutions based on *Teltonika* hardware. These tools should allow external installers to perform vehicle installations without much support. The set of tools includes procedures and manuals for equipment preparation and equipment installation. Furthermore, a web-based installer tool was created for verification of installations and managing hardware, drivers, and vehicles.

Equipment preparation

During preparation of the equipment, SIM-cards are pre-installed, and a configuration template is loaded onto the GPS-tracker. To make the installation procedure as fool-proof as possible, pre-crimped connectors that can only be connected in the correct way are added to the equipment. Figure 46 shows a screenshot taken from the production manual of the solutions based on the FMC640 GPS tracker. The connection scheme shown in the figure highlights how to connect the fool-proof crimp connectors to the equipment during the preparation stage.

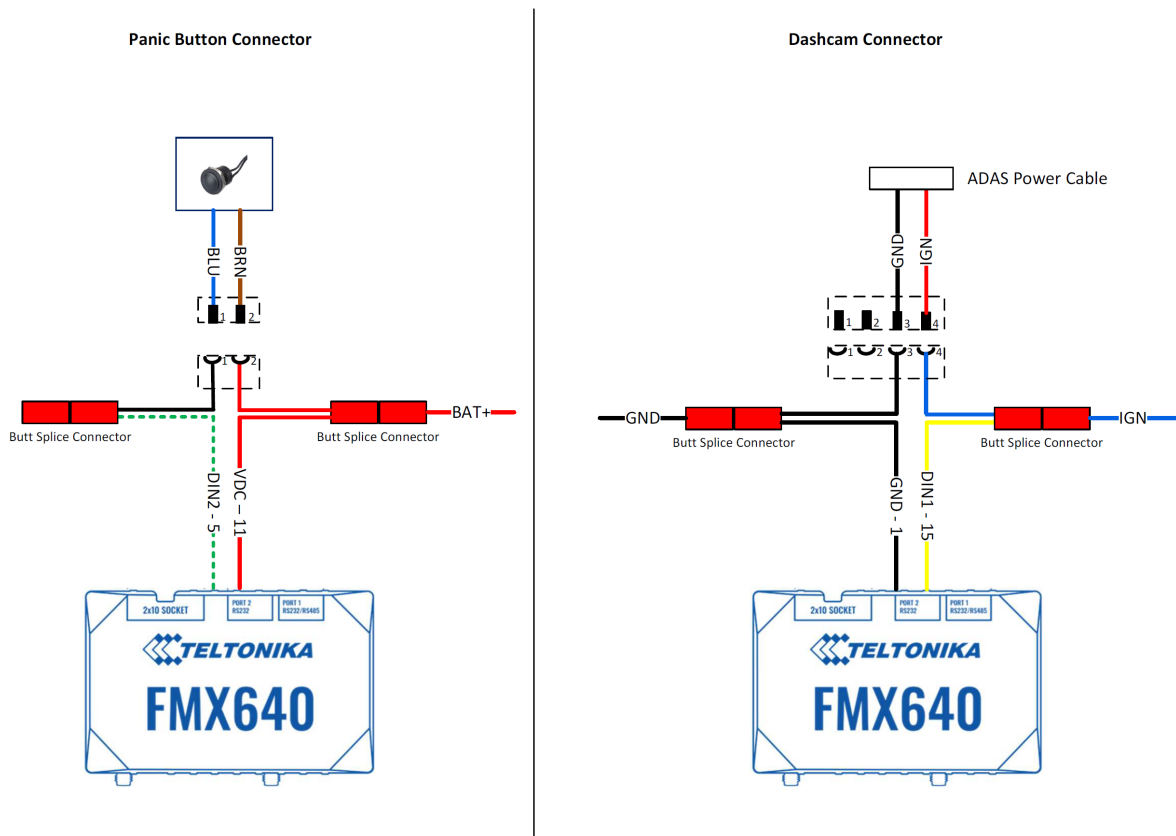

Figure 46: Screenshot taken from the production manual of the solution based on FMC640 GPS tracker.

In-vehicle installation

For the actual installation, detailed manuals were made for each solution, describing every step the installer needs to perform, with pictures and diagrams. Figure 47 shows a screenshot from the installation manual for the solution based on the FMC125 GPS tracker, highlighting how the panic button can be installed in the vehicle.

3 Installation of panic button

The panic button comes with double sided tape. It can be glued to the dashboard or any other part. It is recommended to install the panic button in a location that is out of sight, but also easy to access for the driver.

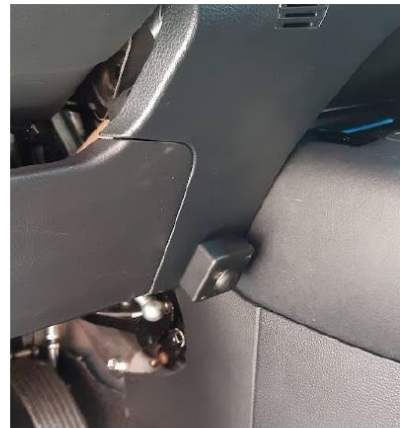

Figure 47: Screenshot taken from the installation manual of the solution based on FMC125 GPS tracker.

Installation verification

After the installation in the vehicle has been finished, installers need to verify whether the system is working correctly. To achieve this, the installation can be verified through the web-based tool provided to the installers. Figure 48 shows a screenshot of the verification tool. By selecting the correct GPS-tracker, and performing some basic actions, key functionalities are automatically checked by the verification tool. The results are displayed to the installer.

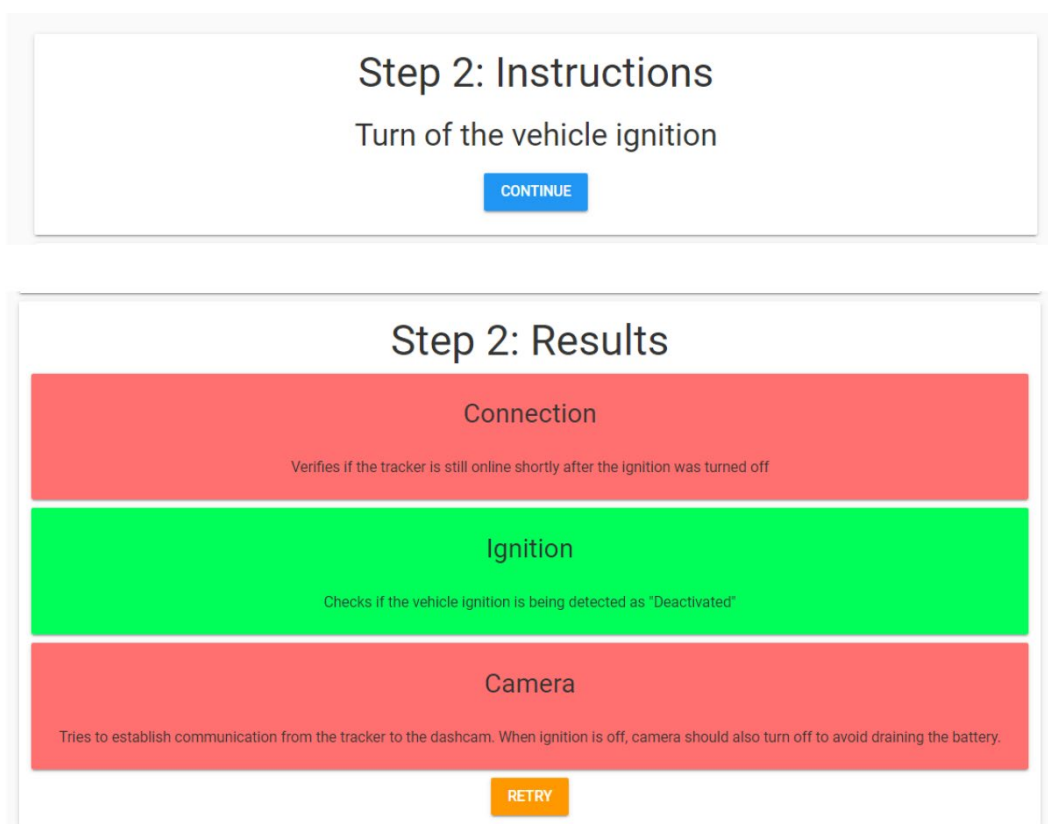

Figure 48: Screenshot of the web-based tool for verification of the installation.

Post-installation health monitoring

The web-based tool also helps installers and fleet managers to monitor the health of existing installations. Common issues related to faulty hardware are automatically inferred from data received from the GPS-trackers. With the click of a button, a fleet-wide report containing the status of equipment can be displayed. Figure 49 shows a screenshot taken from the tool to monitor installation health. The status of several key components is indicated in green (no issues) or red (issue detected). For each status, additional context is also provided, which should help technicians to rapidly narrow down to the underlying issue.

License Plate: Toyota-FMC640-ADAS

Device Type: FMC640_adas_car	IMEI: 8676480480
SIM: 898830300000	Phone :+423663921
Hours logged: 73	Distance logged: 3835 km

Networking Status

Last online: 22/02/2023, 13:44:57 Last trip: 21/02/2023, 23:10:27

GPS Status HIDE MAP

Last known position: [51.116488; 4.644619]

Map Satellite

Map showing location near Berlaar, Netherlands. The map includes labels for Lier, Maasfortbeek, MIJL, Goorloop, Molenvensbeek, and ITEGEM. A red pin is located at Berlaar.

Camera Status

No RS232 COM with ADAS:
First Detected: 25/11/2022, 10:45:33
Last Detected: 17/02/2023, 20:19:43

Figure 49: Screenshot taken from the web-based tool for monitoring installation health.

Annex 2: Results of Literature Review for Knowledge Transfer between Modes

The following tables in the Annex summarize the findings of the literature review targeting the transfer of knowledge between *i*-DREAMS and the aviation (Table 12), maritime (Table 13), and rail (Table 14) sectors. For readability, the tables are presented in landscape orientation.

Table 12: Aviation: Risk factors, monitoring technologies, and interventions.

Definition of risk	Risk factor	Technology	Purpose	Study	Finding
Control errors (e.g., airspeed and altitude deviations)	Fatigue, sleepiness, workload, spatial disorientation, hypoxia, sleep deprivation	Portable and wearable for heart rate (ECG, EEG)	Monitoring	Lehrer et al. (2020); Dehais et al. (2019); Suavet et al. (2014); Majumder et al. (2014); Cardwell (2012)	There are two methods for monitoring pilots' fatigue and situational awareness: (i) ECG and other heart-rate monitoring techniques are considered very reliable for monitoring workload, drowsiness/fatigue, and stress, (ii) eye tracking techniques used to monitor fatigue, drowsiness, and situational awareness.
		Portable and wearable for brain monitoring	Monitoring	Gateau et al. (2018);	
		Eye tracking tech and oculometer	Monitoring	Peissl et al. (2018); Thatcher & Kilingaru (2012); Lounis et al. (2020)	
		Short-acting hypnotics, caffeinated gum, Controlled in-flight rest breaks	In-cabin treatments	Cardwell (2012)	
	Stress	Chest strap sensor and voice recognition	Monitoring	Socha et al. (2016); Luig and Sontacchi (2014)	Speech recognition is used for monitoring stress. A complementary use of unobtrusive sensors would enhance the reliability of monitoring.
	Risk perception	Survey after simulator	Post-trip feedback	Molesworth et al. (2006)	Pilots' feedback on minimum altitude and their perception of risk were evaluated. Post-trip feedback was not that effective mostly because the feedback is helpful when it is in the temporal proximity of the behaviour.
	Situation awareness	Eye tracking	Real-time warning or alert	Chiara et al. (2019); Muehlethaler et al. (2016)	Real-time alerts and warnings improve situation awareness among pilots.
		In-cab display (simulator)	Real-time warning or alert	Sandys et al. 1997; Feary 2005; Creissac Campos and Harrison 2008; Pizziol et al. (2014)	
		Tactile and auditory warnings	Real-time warning or alert	Sklar et al. (1999)	Both tactile conditions resulted in higher detection rates for, and faster response times to, uncommanded mode transitions.
		Post-trip training	Post-trip feedback	Cowings et al. (2009)	Post-trip treatment and training is effective and can improve flying behaviour.

Table 13: Maritime: Risk factors, monitoring technologies, and intervention strategies.

Definition of risk	Risk factor	Technology	Purpose	Study	Finding
Distance Closest Point of Approach (DCPA)	Equipment	Cabin monitoring system	Monitoring	Feng et al. (2020)	Real-time alerts are helpful in reducing the secondary risk of the equipment in the cabin.
	Fatigue, sleepiness, sleep deprivation	Blue light exposure, caffeinated drinks and naps	In-cabin proactive and reactive treatment	Jepsen et al. (2015) Starren, van Hooff et al. 2008; Anund et al. (2015) Grech (2016)	The treatments are effective in supporting the long hours of work and rest requirements.
	Tailgating, overtaking, speed, distance	Collision alert system	Real-time warning or alert	Goerlandt et al. (2015); Zhang et al. (2015); Yamin et al. (2020); Wang et al. (2017); Wu et al. (2019)	The alert systems are effective in reducing the risk based on speed, proximity, and collision course in various scenarios like overtaking, crossing, etc.
	Situation awareness	Visualization software display / real-time alerts	Monitoring & real-time warning or alert	Riveiro et al. (2008); Rhodes et al. (2005)	The visualization tool can help decrease the discrepancy between the perception of environmental elements with respect to time and/or space, the comprehension of their meaning, and the projection of their status after some variable has changed, such as time.

Table 14: Rail: Risk factors, monitoring technologies, and intervention strategies.

Definition of risk	Risk factor	Technology	Purpose	Study	Finding
SPAD (Signal Passed at Danger)	Fatigue, sleepiness, workload	In-cab DAS (Driver Advisory Systems)	Real-time warning or alert	Large et al. 2014	DAS potentially requires additional, possibly conflicting, control actions in addition to those required by speed and signals, needing extra physical and cognitive effort. There may be additional benefits, such as enhancing driver arousal and keeping them in-the-loop.
		Wireless Wearable EEG	Real-time warning or alert	Zhang et al. 2017	A fatigue detection system for high-speed trains based on the driver's vigilance using wireless wearable EEG (around the head) is a valid proposition.
		Heart Rate and Galvanic Skin Response	Real-time warning or alert	Crowley & Balfe 2018	None of the workload measures (task load, subjective, or physiological) was sufficient on its own to measure driver workload, but each has its own strengths and applications.
	Stress, illness	Multimedia	Monitoring	van Vark et al. 1995	Automated stress assessment system was applied to professionals such as air traffic controllers and train drivers. The model consists of several subsystems each of which is based on one medium only and is designed to derive hypotheses about the amount of stress based on that particular medium. Most of the research relates to 'person under the train' incidents.
	Situation awareness, pedestrian detection	PDA's providing DAS	Real-time warning or alert	Tschirner et al. 2013	Of the three DAS considered, none creates comprehensive SA of the current traffic situation. The research shows that drivers have strong interest in the surrounding traffic, need up to date information about the traffic plan, and have valuable information that could improve operative planning. DAS which implements the concepts listed could significantly improve train drivers' SA of current traffic situation and planning.
		In-cab display	Real-time warning or alert	Young & Grenier 2012	New technologies such as ERTMS suggest that the information needs of the future train driver will have a more significant impact upon situation awareness (SA) and performance. Anticipates the cognitive issues faced by future train drivers and posits a new model of display design to support performance. Puts forward field and simulator trials to test and validate the designs.

ANNEX 1 References

- Anund, A., C. Fors, G. Kecklund, W. M. A. van Leeuwen, and T. Åkerstedt. Countermeasures for Fatigue in Transportation. Technical Report, VTI, 2015.
- Baysari, M. T., C. Caponecchia, A. S. McIntosh, and J. R. Wilson. Classification of Errors Contributing to Rail Incidents and Accidents: A Comparison of Two Human Error Identification Techniques. *Safety Science*, Vol. 47, No. 7, 2009. <https://doi.org/10.1016/j.ssci.2008.09.012>.
- Brookhuis, K.A., De Waard, D. and Janssen, W.H., 2001. Behavioural impacts of advanced driver assistance systems—an overview. *European Journal of Transport and Infrastructure Research*, 1(3).
- Caldwell, J. A. Crew Schedules, Sleep Deprivation, and Aviation Performance. *Current Directions in Psychological Science*, Vol. 21, No. 2, 2012. <https://doi.org/10.1177/0963721411435842>.
- Crowley, K., and N. Balfe. Investigation of Train Driver Physiological Responses. 2018.
- Debnath, A. K., and H. C. Chin. Navigational Traffic Conflict Technique: A Proactive Approach to Quantitative Measurement of Collision Risks in Port Waters. *Journal of Navigation*, Vol. 63, No. 1, 2010. <https://doi.org/10.1017/S0373463309990233>.
- Dehais, F., B. Somon, T. Mullen, and D. E. Callan. A Neuroergonomics Approach to Measure Pilot's Cognitive Incapacitation in the Real World with EEG. No. 1201 AISC, 2021.
- Feng, X., L. Yang, and H. Zhang. Design of the Dual Redundant Controller in the Cabin Monitoring System. 2020.
- Goerlandt, F., J. Montewka, V. Kuzmin, and P. Kujala. A Risk-Informed Ship Collision Alert System: Framework and Application. *Safety Science*, Vol. 77, 2015. <https://doi.org/10.1016/j.ssci.2015.03.015>.
- Grant, E., P. M. Salmon, N. J. Stevens, N. Goode, and G. J. Read. Back to the Future: What Do Accident Causation Models Tell Us about Accident Prediction? *Safety Science*. Volume 104.
- Huang, Y., L. Chen, P. Chen, R. R. Negenborn, and P. H. A. J. M. van Gelder. Ship Collision Avoidance Methods: State-of-the-Art. *Safety Science*. Volume 121.
- Jensen, R. S. The Boundaries of Aviation Psychology, Human Factors, Aeronautical Decision Making, Situation Awareness, and Crew Resource Management. *The International Journal of Aviation Psychology*, Vol. 7, No. 4, 1997. https://doi.org/10.1207/s15327108ijap0704_1.
- Jepsen, J. R., Z. Zhao, and W. M. A. van Leeuwen. Seafarer Fatigue: A Review of Risk Factors, Consequences for Seafarers' Health and Safety and Options for Mitigation. *International maritime health*. 2. Volume 66.
- Jones, D. G., and M. R. Endsley. Sources of Situation Awareness Errors in Aviation. *Aviation Space and Environmental Medicine*, Vol. 67, No. 6, 1996.
- Kaiser, S., Eichhorn, A., Aigner-Breuss, E., Pracherstorfer, C., Katrakazas, C., Michelaraki, E., Yannis, G., Pilkington-Cheney, F., Talbot, R., Hancox, G. and Polders, E. D2.1 State of the Art on Monitoring Driver State and Task Demand.
- Kang, L., Z. Lu, Q. Meng, S. Gao, and F. Wang. Maritime Simulator Based Determination of Minimum DCPA and TCPA in Head-on Ship-to-Ship Collision Avoidance in Confined Waters. *Transportmetrica A: Transport Science*, Vol. 15, No. 2, 2019. <https://doi.org/10.1080/23249935.2019.1567617>.
- Katrakazas, C., Michelaraki, E., Yannis, G., Kaiser, S., Senitschnig, N., Ross, V., Adnan, M., Brijs, K., Brijs, T., Talbot, R. and Pilkington-Cheney, F. D3. 2 Toolbox of Recommended Data Collection Tools and Monitoring Methods and a Conceptual Definition of the Safety Tolerance Zone. 2020.
- Kharoufah, H., J. Murray, G. Baxter, and G. Wild. A Review of Human Factors Causations in Commercial Air Transport Accidents and Incidents: From 2000–2016. *Progress in Aerospace Sciences*. Volume 99.
- Large, D. R., D. Golightly, and E. L. Taylor. The Effect of Driver Advisory Systems on Train Driver Workload and Performance. 2014.
- Lehrer, P., M. Karavidas, S. Lu, E. Vaschillo, B. Vaschillo, and A. Cheng. Cardiac Data Increase Association between Self-Report and Both Expert Ratings of Task Load and Task Performance in Flight Simulator Tasks: An Exploratory Study. *International Journal of Psychophysiology*, Vol. 76, No. 2, 2010. <https://doi.org/10.1016/j.ijpsycho.2010.02.006>.
- Louie, V. W., and T. L. Doolen. A Study of Factors That Contribute to Maritime Fatigue. *Marine Technology and SNAME News*, Vol. 44, No. 2, 2007. <https://doi.org/10.5957/mt1.2007.44.2.82>.
- Majumder, S., A. K. Verma, C. Wang, A. Mohamud, L. Archer, K. Tavakolian, and N. Wilson. Using Photoplethysmography Based Features as Indicators of Drowsiness: Preliminary Results. 2019.
- Marchiori, D. R., M. A. Adriaanse, and D. T. D. de Ridder. Unresolved Questions in Nudging Research: Putting the Psychology Back in Nudging. *Social and Personality Psychology Compass*, Vol. 11, No. 1, 2017. <https://doi.org/10.1111/spc3.12297>.

- Molesworth, B. R. C., and B. Chang. Predicting Pilots Risk-Taking Behavior through an Implicit Association Test. *Human Factors*, Vol. 51, No. 6, 2009. <https://doi.org/10.1177/0018720809357756>.
- Naweed, A., J. Chapman, and J. Trigg. "Tell Them What They Want to Hear and Get Back to Work": Insights into the Utility of Current Occupational Health Assessments from the Perspectives of Train Drivers. *Transportation Research Part A: Policy and Practice*, Vol. 118, 2018. <https://doi.org/10.1016/j.tra.2018.08.008>.
- Papadimitriou, E., C. Schneider, J. Aguinaga Tello, W. Damen, M. Lomba Vrouwenraets, and A. ten Broeke. Transport Safety and Human Factors in the Era of Automation: What Can Transport Modes Learn from Each Other? *Accident Analysis and Prevention*, Vol. 144, 2020. <https://doi.org/10.1016/j.aap.2020.105656>.
- Pazouki, K., N. Forbes, R. A. Norman, and M. D. Woodward. Investigation on the Impact of Human-Automation Interaction in Maritime Operations. *Ocean Engineering*, Vol. 153, 2018. <https://doi.org/10.1016/j.oceaneng.2018.01.103>.
- Pilkington-Cheney, F., A. P. Afghari, A. Filtness, E. Papadimitriou, A. Lourenço, and T. Brijs. The I-DREAMS Intervention Strategies to Reduce Driver Fatigue and Sleepiness for Different Transport Modes. 2021.
- Rhodes, B. J., N. A. Bomberger, M. Seibert, and A. M. Waxman. Maritime Situation Monitoring and Awareness Using Learning Mechanisms. No. 2005, 2005.
- Riveiro, M., G. Falkman, and T. Ziemke. Improving Maritime Anomaly Detection and Situation Awareness through Interactive Visualization. 2008.
- SAE International. Taxonomy and Definitions for Terms Related to Driving Automation Systems for On-Road Motor Vehicles J3016. SAE International. J3016. Volume J3016.
- Snidaro, L., I. Visentini, and K. Bryan. Fusing Uncertain Knowledge and Evidence for Maritime Situational Awareness via Markov Logic Networks. *Information Fusion*, Vol. 21, No. 1, 2015. <https://doi.org/10.1016/j.inffus.2013.03.004>.
- Stanton, N. A., P. R. G. Chambers, and J. Piggott. Situational Awareness and Safety. *Safety Science*, Vol. 39, No. 3, 2001. [https://doi.org/10.1016/S0925-7535\(01\)00010-8](https://doi.org/10.1016/S0925-7535(01)00010-8).
- Tschirner, S., A. W. Andersson, and B. Sandblad. Designing Train Driver Advisory Systems for Situation Awareness. 2013.
- van Vark, R. J., L. J. M. Rothkrantz, and E. J. H. Kerckhoffs. Automated Stress Assessment for Train Drivers. 1995.
- Wang, X., Z. Liu, and Y. Cai. The Ship Maneuverability Based Collision Avoidance Dynamic Support System in Close-Quarters Situation. *Ocean Engineering*, Vol. 146, 2017. <https://doi.org/10.1016/j.oceaneng.2017.08.034>.
- Weijermars, W., N. Bos, A. Filtness, L. Brown, R. Bauer, E. Dupont, J. L. Martin, K. Perez, and P. Thomas. Burden of Injury of Serious Road Injuries in Six EU Countries. *Accident Analysis and Prevention*, Vol. 111, 2018. <https://doi.org/10.1016/j.aap.2017.11.040>.
- Wouters, P.I. and Bos, J.M., 2000. Traffic accident reduction by monitoring driver behaviour with in-car data recorders. *Accident Analysis & Prevention*, 32(5), pp.643-650.
- Young, M. S., and D. P. J. Grenier. Future Train Cab Interface Design: Development OFA Model to Support Driver Situation Awareness. 2012.
- Zhang, W., F. Goerlandt, J. Montewka, and P. Kujala. A Method for Detecting Possible near Miss Ship Collisions from AIS Data. *Ocean Engineering*, Vol. 107, 2015. <https://doi.org/10.1016/j.oceaneng.2015.07.046>.
- Zhang, X., J. Li, Y. Liu, Z. Zhang, Z. Wang, D. Luo, X. Zhou, M. Zhu, W. Salman, G. Hu, and C. Wang. Design of a Fatigue Detection System for High-Speed Trains Based on Driver Vigilance Using a Wireless Wearable EEG. *Sensors (Switzerland)*, Vol. 17, No. 3, 2017. <https://doi.org/10.3390/s17030486>.

Annex 3: Expert Interview Questionnaire For Knowledge Transfer Between modes

Introduction

- Welcome and thanks for coming
- Introduce X– TUD’s role – project overview - interviews to get your perspective on the current state of safety systems in your industry.
- Informal discussion about your experiences of safety-related technology and how it is managed in the maritime industry – your feedback is really important as it will help us to investigate whether the iDREAMS system in principle could be applied to maritime. Please feel free to have your say and we’d really appreciate your openness.
- All information you provide will be kept confidential, no individuals will be identified in any reports

Introductory Question

- Before we go into specific questions, we’d just like to learn a little bit about your background – what brought you to this role?
- What does your job entail? How long have you been doing your current role?
- What are the three biggest safety challenges for your industry? Here we are thinking about the operator, the vessel and the environment around them rather than events such as collision scenarios.

DIRECTION 1

- Could you tell me about your understanding of safety systems currently fitted to vessel bridges? [A safety system is here defined as a technological system which is designed to respond to a potential hazard or incident and to take the vessel and/or operator to a safe state when predetermined conditions are violated.]
- In your opinion, which are the most important safety systems currently installed in the bridge?
- Would you consider any of these as essential? For example, features without which you believe it would not be safe to navigate the ship?
- Can you think of any safety devices in addition to what exists that should trigger in-cab warnings to assist operators and improve safety?
- Could you tell me about your understanding of safety systems currently fitted outside the bridge (vessel-based or remote)?
- In your opinion, which are the most important safety systems originating outside the bridge? [remember to consider the driver, environment and vehicle from iDreams context. Probe more about how these and those in the cab could inform other transport contexts]
- In your opinion, which is the most beneficial for safety: monitoring an operator, monitoring the environment or monitoring the ship? Please could you explain your answer?
- To what extent do you think the safety systems that are currently available are beneficial for avoiding a collision scenario (e.g. critical CPA)?

[EXPLAIN THE iDREAMS concept and the STZ – provide a document in advance of the interview]

DIRECTION 2

Does the STZ map on to the maritime context?

The purpose of the next section is to think about what each stage of the Safety Tolerance Zone might look like in a maritime context. [Consider operator, vessel, traffic control, infrastructure, schedule etc – anything that could influence the navigating task].

- Can you describe the characteristics of the operator, vessel and the environment around them during a ‘normal’ minimal risk trip (equivalent to the STZ first, normal, phase)? [Might also cover operator aspects, culture and regulations]
 - Prompt questions: how do you think a minimal risk trip looks?
- What factors can change for the operator, vessel and the environment around them which reduce the safety of the navigation but might not directly lead to a collision (equivalent to the STZ second, danger phase)?
 - Prompt questions: What factors would increase the *likelihood* of a critical CPA occurring? Are these covered by existing safety systems? What are the gaps?
- Please give examples of factors that would require action from the operator (or wider systems around them) to prevent a safety-critical incident (equivalent to STZ third, avoidable collision phase)?
 - Prompt questions: What factors can lead to a collision risk? Are all of these addressed by current safety systems? Are there any gaps?

[For vessels:

- Normal driving phase: driver alert, good weather conditions, navigating to schedule etc.
- Danger phase: obstacles at sea; operator becoming sleepy or distracted (less likely to trigger existing technology)
- Avoidable crash phase: A collision course occurs; existing technology is triggered.]

What are the current gaps in safety warnings that could be filled by the iDreams system?

- If it was possible to measure, would it be useful to have an in-cab alert/warning which told drivers about transition between these STZ phases? Why/why not?
- What would be required or changed for this type of approach to be implemented and made useful? What would be the barriers to this type of approach?
- In the context of cars iDREAMS is concerned with overtaking and headway, factors which are not directly relevant to vessels. Are there any other issues (e.g. speed or fatigue) relating to the vessel and operator that would benefit from warnings or alerts?
- Could interventions related to fatigue, sleepiness and workload be incorporated into the current safety context? How could this be achieved?
- Could interventions related to stress or illness be incorporated into the current safety context? How could this be achieved?

- Could interventions related to situation awareness or risk detection be incorporated into the current safety context? How could this be achieved?

Could post-trip feedback/coaching be used to improve safety?

iDREAMS has designed a tool that allows information to be given to the road driver about their driving and ways in which it could be improved after they have undertaken a journey. This includes feedback – an example for cars would be the number of times travelled over speed limit – and coaching, for example, hints, tips and information on safe behaviour and how to improve driving.

- Thinking about this type of feedback being received about previous navigating, is anything like this already used in your industry? How does it work? If not, then how do you think it might work? Do you think there is a best way this type of approach could be used to improve safety?
- If an organisation brought in a system to give feedback on previous trips how do you think it would be received? What would stop it working?
- How would you describe the overall safety culture in your industry? How do you think post-trip feedback/coaching would fit into this general safety culture?
- Is there anything else that you think should be considered when trying to design new real-time or post-trip approaches to enhance safe driving?

Closing

- Any other comments/questions?
- Thanks